

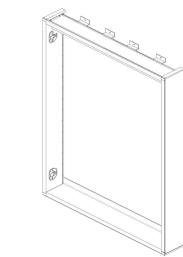

Assembling Instruction

SKU: ABMC2630BT

Products List:

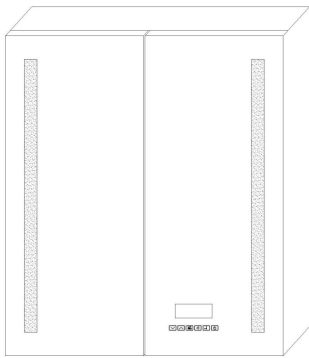

Cabinet(1pc)

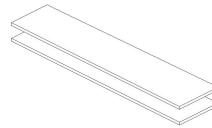

Tempered Glass Shelves(2pcs)

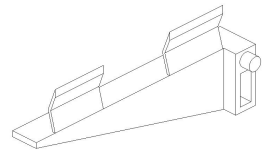

Shelves supports(4pcs)

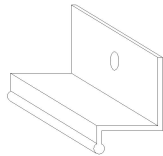

Top Plate (assemble on the cabinet by Supplier)(4pcs)



Bottom Plates(1pcs)

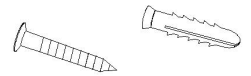

Screws/Thread Plugs(8pcs each)

Assembling Cabinet (See Images 1)

1. Fixing Bottom plate on the wall , make sure it is horizontal.
2. Put the cabinet on the bottom plate, and the bottom plate will lock the cabinet and support the cabinet
3. Then fixing the top plate, please note it must be horizontal.

IMAGES 1

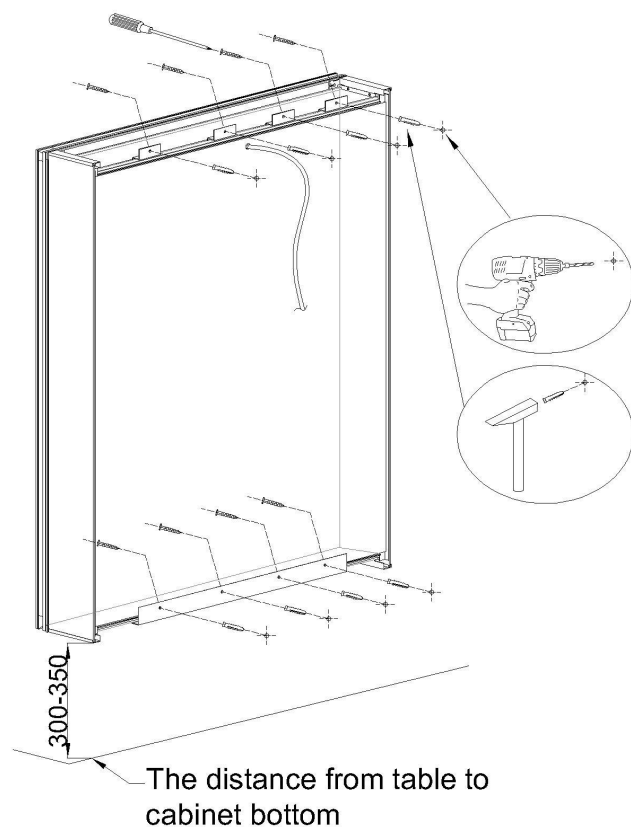

Assembling Glass shelves (See Images 2)

1. Please fixing according A-B-C
2. Please note left-right shelf supports should be accordance
3. Glass shelf should be slope in the cabinet when fixing the supports. Then please press the glass make sure it firm

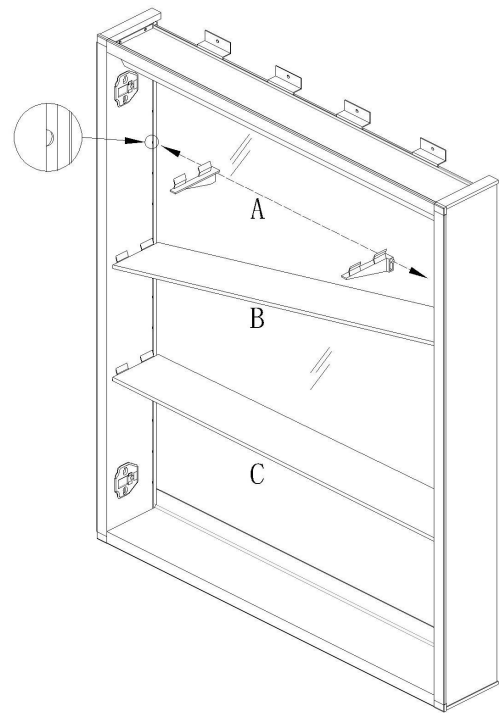

IMAGES 2

Assemble & Disassemble & Adjust Hinge

The cabinet use clip hinge, assemble and disassemble is opposite. (See Images 3)

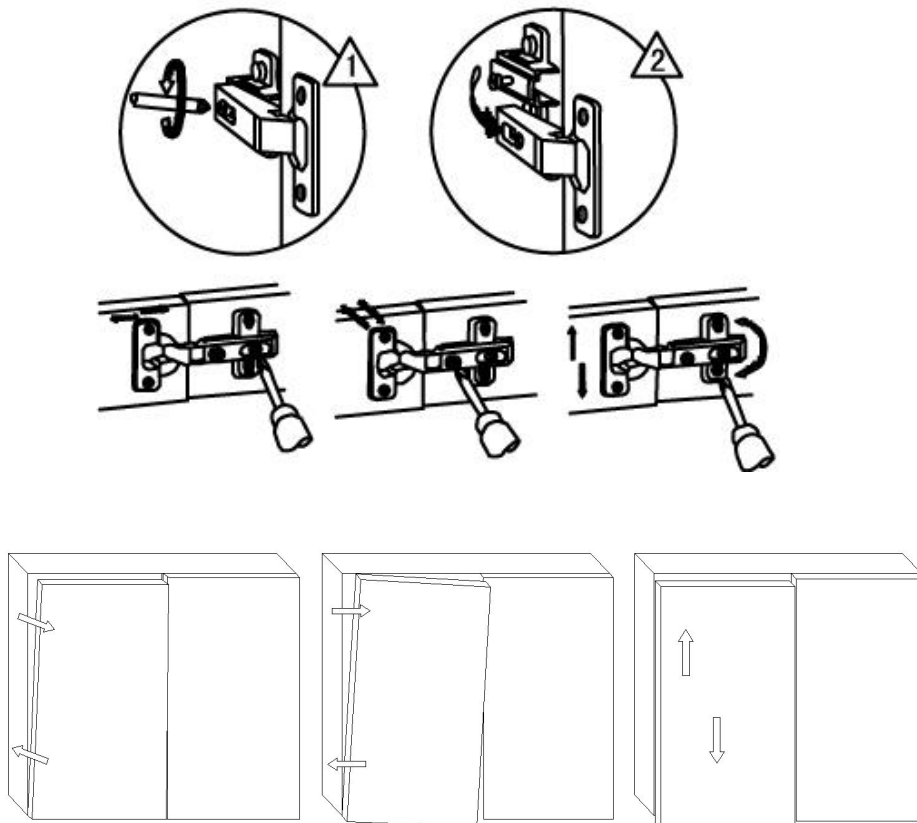

IMAGES 3