

TRADITIONAL T-2040

INSTALLATION INSTRUCTIONS



WARNINGS

PLEASE READ THE FOLLOWING INFORMATION BEFORE INSTALLING AND USING YOUR HEATED TOWEL RACK.

1. These units should be installed by a certified electrician in accordance with the National Electrical Code (NEC) and the Canadian Electrical Code (CEC).
2. The unit requires a 115 volt, 60Hz power source and should be installed on a GFCI protected circuit.
3. Follow installation instructions to ensure unit is securely fixed to wall. Unit is designed for drying towels. Under no circumstances should anybody climb on or hang on unit.
4. The unit must be installed in an upright position with the wire cover tube/junction box being positioned at the bottom.
5. Unit is intended for indoor use only. Do not place units inside a shower, sauna, steam room, or wherever unit would be exposed to water.
6. **To reduce the risk of electric shock, burns, fire or injury:**
 - Close supervision is necessary when this unit is used near children or disabled persons.
 - Use this unit only for its intended use as described in this manual.
 - Do not use outdoors.
 - Do not operate with a voltage converter.
 - Do not touch hot surfaces.
 - Do not use accessories or attachments not recommended by the manufacturer as this may cause injuries.

CAUTION

1. As this is a heating device, the surface temperature can increase depending on the ambient temperature in the room and the number of towels applied to the unit.
2. The fasteners provided with the installation kit are for convenience only and are not suitable for all installation conditions.
3. It is the ultimate responsibility of the installer to ensure proper mounting hardware is employed in attaching the unit to the wall.

OPERATING INSTRUCTION

1. After installation, connect the electric power.
2. Turn on the wall switch (sold separately) and towel warmer will start to heat-Allow 30-40 minutes to heat up.
3. This towel warmer has been designed to run continuously- turn off at wall switch when the towel warmer is not in use for long periods of time.

CARE AND MAINTENANCE

1. Towels which contain soap or detergent residue may appear to have scorch marks; this is simply discoloration of the residue in the towels themselves.
2. The unit is constructed from extremely durable low carbon steel. To maintain a good appearance, follow these simple instructions:
 - For routine cleaning, simply switch off the unit, allow to cool to room temperature, wipe with a damp cloth and buff with a soft, dry cloth.
 - Under no circumstances should abrasive cleaners be used to clean the unit.
 - If the product is damaged, do not repair by yourself, please return to the maintenance center for possible repair.

INCLUDED COMPONENTS

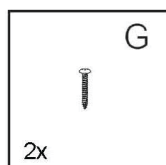
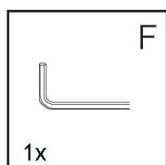
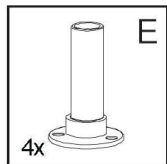
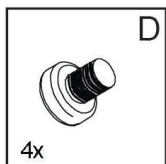
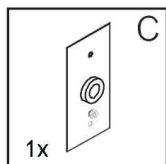
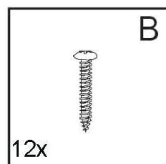
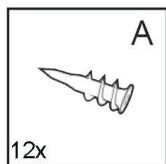

ELECTRICAL INFO

WATTS	AMPS	VOLTS
150	1.3	115

TOOLS RECOMMENDED

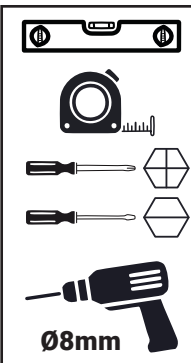

WARRANTY

Two year limited warranty with proof of purchase will apply if all Terms and Conditions of Sale are met and Installation Instructions are adhered to.



TRADITIONAL T-2040

INSTALLATION INSTRUCTIONS

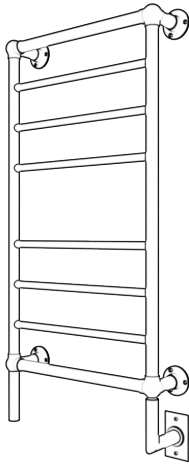

PARAMETER

CONFORMS TO UL STD.499
 CERTIFIED TO CSA
 STD C22.2 NO.64
 TOWEL WARMER
 MODEL: T-2040
 Rated Voltage: 115V~
 Rated Frequency: 60hz
 Rated Power Input: 150W
 Serial NO:

CAUTION:
 HOUSEHOLD USE ONLY
 DO NOT IMMERSE IN WATER
 HOT SURFACE - AVOID CONTACT

ATTENTION :
 UTILISATION DOMESTIQUE UNIQUEMENT
 NE PAS PLONGER DANS L'EAU
 SURFACE CHAUDE - ÉVITEZ LE CONTACT

AVAILABLE MODELS

T-2040PN
 POLISHED NICKEL

T-2040BN
 BRUSHED NICKEL

T-2040BB
 BRUSHED BRONZE

Liquid-filled models MUST be installed with the wire cover tube/junction box being positioned at the bottom.

CONTACT

TEL:
 +1(404)350-9738
FAX:
 +1(404)355-0166

EMAIL:
 customerservice@ambaproducts.com
WEBSITE:
 www.ambaproducts.com

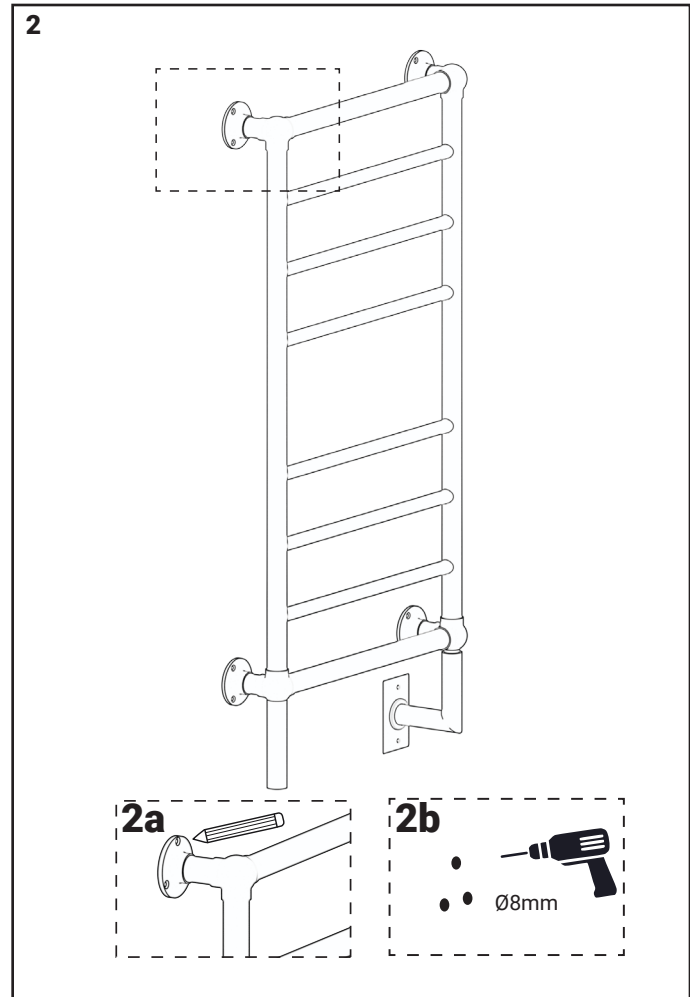
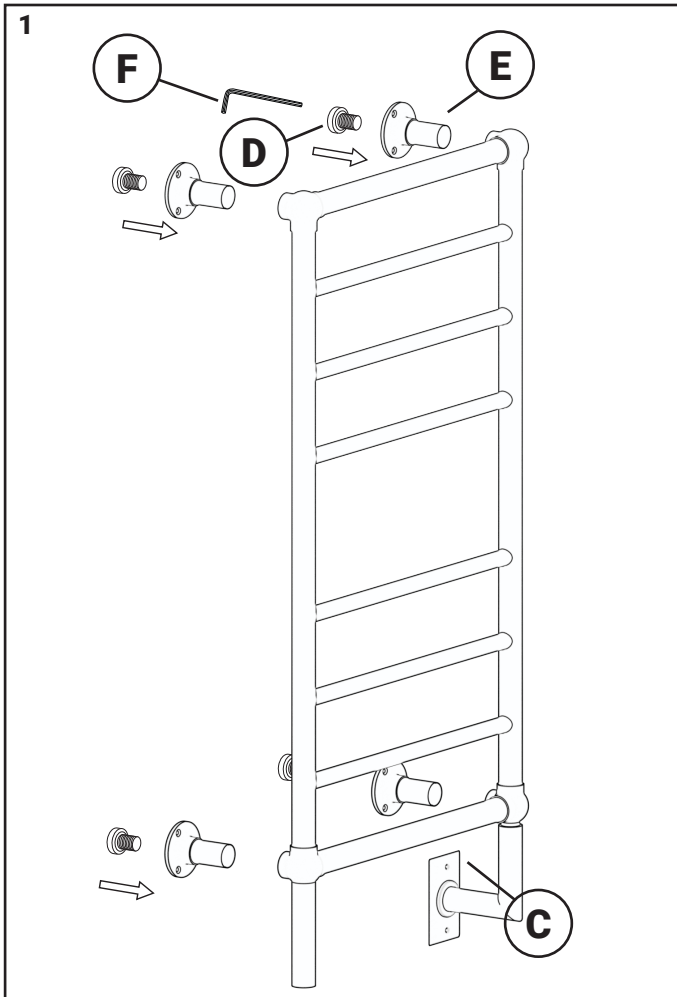

TRADITIONAL T-2040

INSTALLATION INSTRUCTIONS

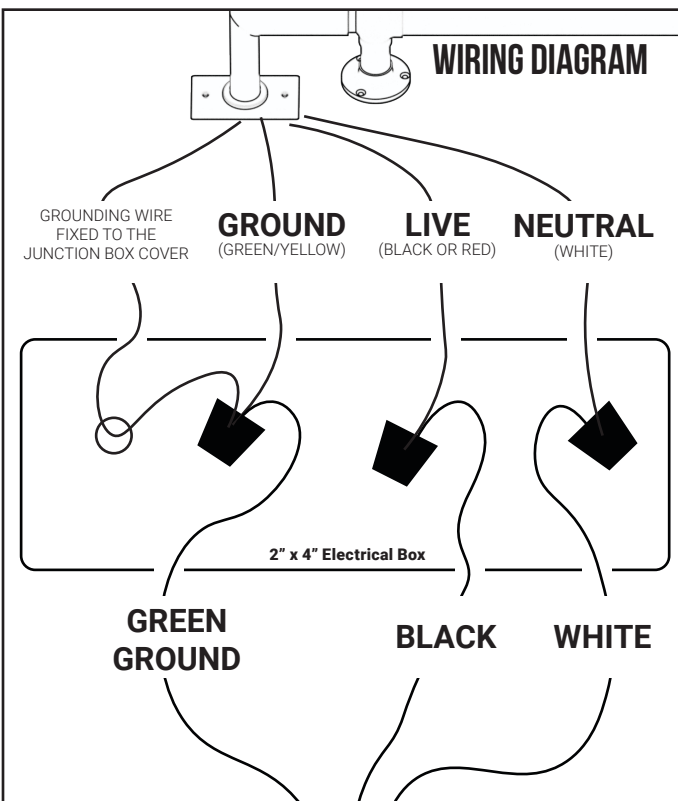
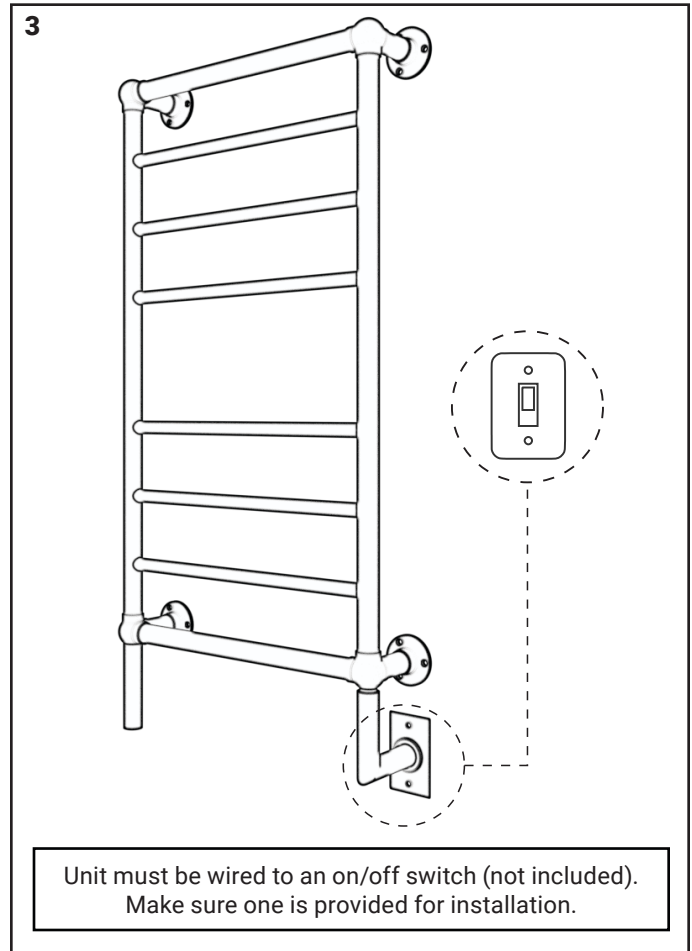
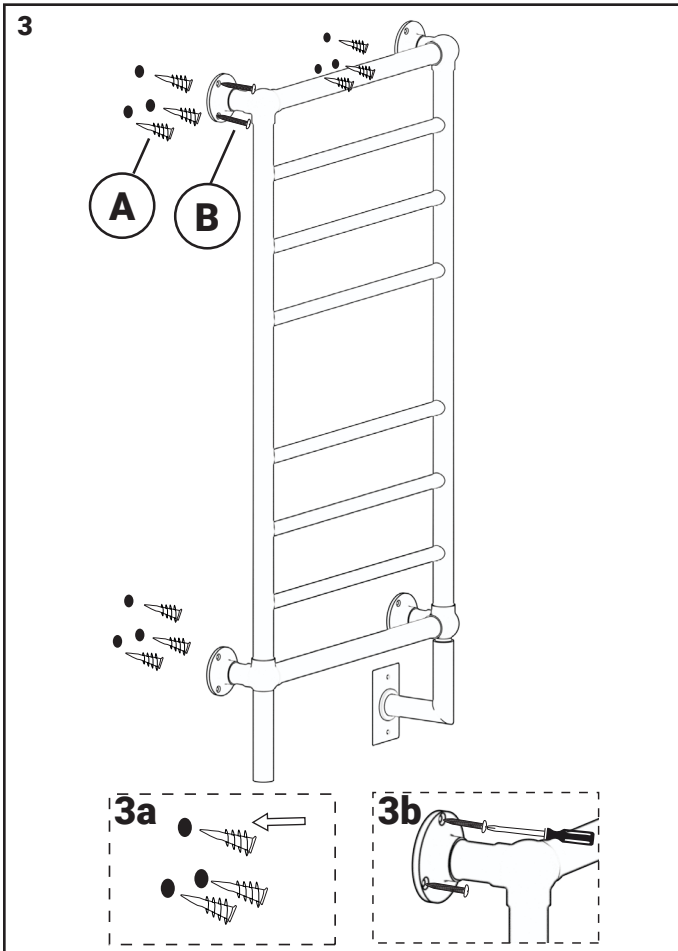

! CAUTION – SURFACE OF UNIT IS HOT WHEN ON !