

TOTO

TOTO U.S.A., Inc. 1155 Southern Road Morrow, GA 30260
Phone : (770) 282-8686

Warranty Registration and Inquiry
For product warranty registration, TOTO U.S.A. Inc. recommends On-Line Warranty Registration. Please visit our web site <http://www.totousa.com>. If you have questions regarding warranty policy or coverage, please contact TOTO U.S.A. Inc., Customer Service Department, 1155 Southern Road, Morrow, GA 30260 (888) 295 - 8134 or (678) 466 - 1300 when calling from outside of U.S.A.

- You are advised to record the following information to allow quick service.

Date of purchase :	Name of shop :
Date : year month day	Tel : ()



This code is for manufacturer management use.

2025.10.7
D07M42

TOTO NEOREST LS

Instruction Manual

If the water does not flow due to a power outage. (→Page 56)



NEOREST

SN8732M (MS8732CUMFG)



Thank you for your recent purchase of this product.
Please read the enclosed information to ensure the safe use of your product.

Be sure to read this Instruction Manual before using your product and keep it in a safe place for future reference.

Table of Contents

Introduction

Safety Precautions	4
Operational Precautions	9
Parts Names	12
Preparation	14
Using the Product for the First Time.....	14

Operation

Basic Operations	16
Mechanism of Auto Functions	16
Auto open / close.....	16
Auto bowl CLEAN	16
Instant heated seat	16
Deodorizer	16
Auto power deodorizer	16
Auto flushing.....	16
Auto wand CLEAN	17
Auto underseat CLEAN.....	17
Soft light	18
CLEAN indicator	18
Using the Remote Control	19
Stop.....	19
Rear washing.....	19
Rear soft washing	19
Front washing	19
Wide front washing	19
Water pressure adjustment	19
Wand position adjustment	19
Warm air drying	19
Oscillating washing	19
Pulsating washing.....	19
Full flush.....	20
Light flush	20
Wand CLEAN	20
Personal setting	20
Opening and closing the toilet lid	20
Opening and closing the toilet seat	20
Low battery warning LED.....	20
Menu, Return button	21
Temperature adjustment button	21
Power ON/OFF button	21
SELECT keys	21
Enter button.....	21
Display screen	21
About the Menu Screen	22

Temperature Adjustment.....	24
Warm Water, Toilet Seat, Drying	24
Changing Settings.....	26
Setting List	26
The energy saver features.....	28
How to Set	29
Auto energy saver+.....	29
Timer energy saver.....	29
Auto flushing.....	30
Auto flush lid closed.....	30
Auto flush delay	32
Auto open / close.....	32
Auto close delay	33
Auto open delay.....	34
Seat/lid	34
Auto wand CLEAN	35
Auto bowl CLEAN	36
Auto underseat CLEAN.....	36
Deodorizer	37
Auto power deodorizer.....	37
Night light	38
Soft light	39
Bowl light.....	39
CLEAN indicator	40
Language settings	40
Anti freezing	41
Beep sound	42
Lower water level.....	42
Pressure/position setting	43
Personal setting.....	43
Registering Personal Settings.....	44
Sensor detection range.....	45

Maintenance

Maintenance	46
Before Maintenance	46
Power Plug	46
Top unit and bowl unit maintenance.....	47
Top Unit	47
Bowl Unit	48
Bowl unit cleaning.....	48
If you notice limescale build-up on the top unit and bowl unit.....	49
Manual Spray	50
Deodorizing Filter	50
Gap between the Top Unit and Bowl Unit.....	51
Gap between the Top Unit and the Toilet Lid ..	52
Wand.....	53
Wand cleaning	53
Drain Plug With Water Supply Filter.....	54
Water Supply Filter (Bowl Unit).....	55

Reference

What to Do?	56
If the water does not flow due to a power outage (when water failure hasn't occurred)	56
If the water does not flow due to a water service interruption	58
If you cannot operate with the remote control	58
Replacing the batteries	58
Freeze Damage Prevention	59
Long Periods of Disuse.....	60
How to drain the water	60
Resupplying the Water.....	61
How to remove the operation guide	62
Troubleshooting	63
Please check first	63
Rear Washing, Front Washing and Wand.....	64
Warm air drying	65
Flushing	65
Toilet Seat and Toilet Lid (Auto open / close).....	67
Toilet Seat and Toilet Lid.....	69
Auto flush lid closed.....	70
Energy Saver.....	70
Deodorizer.....	71
Auto bowl CLEAN, Auto underseat CLEAN....	71
Lights	72
Others	72
Specifications	75
Limited Warranty	78

The images shown are for illustration purposes only and may not be an exact representation of the product.

Safety Precautions

IMPORTANT SAFEGUARDS

READ ALL INSTRUCTIONS BEFORE USING

Symbols and Meanings

 **WARNING** May result in death or serious injury.

 **CAUTION** May result in injury or property damage.

WARNING

Never disassemble, repair or alter.

Doing so may cause fire, electrical shock, overheating, short circuit or breakdown.

Do not use the product if a malfunction occurs.

In case of breakdown or other problem, be sure to cut off power by means such as unplugging the power plug or switching the breaker in the distribution board to OFF, etc.

Close the water shutoff valve to stop water supply.

Possible malfunctions:

- Water is leaking from a pipe or the top unit.
- The product is cracked or broken.
- The product makes a strange noise or emits a strange odor.
- The product emits smoke.
- The product is abnormally hot.
- The bowl unit is clogged.
- The toilet seat cushion is out of place.

Continued use after malfunction could cause a fire, electrical shock, heat, short circuit, injury or water damage.

Do not use other water than allowed by the laws and ordinances of the region of use. Only use potable water.

Do not use seawater or recycled water.

Doing so may cause irritation to the skin and malfunction.

Keep cigarettes and other open flames away from the product.

Failure to do so may cause fire.

Refrain from sitting on the seat for long periods.

It may cause low-temperature burns.

To prevent the following persons from getting a moderate temperature burn during use, other person should turn off the toilet seat heater and set the dryer temperature to "Low".

- Young children, the aged and other users unable to set the temperature appropriately themselves.
- The ill, physically disabled and others who do not have freedom of movement.
- Those using any medicines that cause drowsiness (sleeping or cold medicine), those who have been drinking heavily, anyone severely fatigued and anyone else liable to fall asleep.

If the power cord is damaged, avoid danger by having the manufacturer's repair department or equivalent specialist replace it.

Turn the power OFF before maintenance or inspection.*1

Failure to do so may cause electrical shock or malfunction.

When leaking battery fluid adheres to your body or clothes, wash it away with clean water.

The fluid may damage your eyes or skin.

Do not stick a finger or anything else into the warm air outlet.

Do not place anything on the warm air outlet or drape clothes over it.

Doing so may cause burns, electrical shock or malfunction.

WARNING

Do not install the product on moving vehicles such as wheeled vehicles or boats.

Doing so may cause fire, electric shock, short circuit or malfunction.

The toilet seat, toilet lid, top unit, or other parts may come loose and fall off, resulting in injury.

Do not use any power supply other than the one specified.

AC 120 V, 60 Hz

Doing so may cause fire or excessive heat.

This is an electrical product. Do not install it anywhere water is likely to get on the product or anywhere with humidity high enough that water is likely to form on the surface of this product. When using the product in a bathroom, install a fan or ventilation port and ensure good air flow through the bathroom.

Failure to do so may cause fire or electrical shock.

Always connect the product to the cold water supply.

Connecting to hot water supply may result in burns and equipment damage.

Preliminary studies in females suggest that overuse of continuous spraying can increase the possibility of vaginal mucosa drying and potential reduction in desirable microbial organisms.

Although these studies have not been validated, please consult your healthcare provider for concerns regarding whether these circumstances may apply to you.

More importantly, if you are an individual suffering from any immune deficiency as a result of disease, chemotherapy, or other medical condition compromising the immune system you should consult your healthcare provider before use of this product.

Do not touch the connection of power cord with wet hands.

Doing so may cause electrical shock.

Do not get any water or cleaning solution on the gap between the top unit and bowl unit or power supply connections.

Doing so may cause fire, electrical shock, heat or short circuit.

Doing so may cause the product to crack resulting in injury or water damage.

Do not touch the power source connection during thunderstorms.

Doing so may cause electrical shock.

Do not allow the water supply hose to touch the power source connection.

Doing so may cause condensation resulting in a fire, electrical shock, heat or a short.

Do not do anything that may damage the power cord or power source connection.

Do not strike, yank, twist, excessively bend, damage, alter, or heat the power cords.

Also, do not place anything heavy on, bind or pinch the power cords.

Using a damaged power cord may result in a fire, electrical shock, heat or short.

Confirm that a properly grounded outlet has been installed.

Failure to install a grounded outlet could cause electrical shock in the event of a malfunction.

*If there is no ground installed, ask the contractor who did the installation to install the ground.

Periodically remove dust and dirt from the power plug and make sure it is securely plugged into the wall outlet.

Failure to do so may cause fire, heat or short circuit. Pull the power plug out from the outlet and wipe clean with a dry cloth.

*1 How to turn off the product (→Page 15)

Safety Precautions

WARNING

Do not use a loose or faulty electrical outlet.

Doing so may cause fire or short circuit.

Do not use any outlet beyond its specified rating.

Plugging too many plugs into the same outlet, for example using outlet splitters, can cause fire due to heat.

Insert the power plug securely into the outlet.

Failure to do so may cause fire, heat or short circuit.

To unplug, hold the power plug, not the power cord.

Do not unplug by pulling the power cord.

Pulling on the power cord may cause damage and result in fire or heat.

CAUTION

Do not use the product if the top unit is unstable.

Doing so may cause the top unit to come loose and fall, resulting in injury.

If the product is damaged, do not touch the damaged section.

Doing so may cause electrical shock or injury. Replace it immediately.

Do not use the product while the top unit is lifted up by the cleaning lift.

When lowering the top unit by the cleaning lift, do not insert your fingers into the gap between the top unit and the bowl unit.

Do not apply strong force, mechanical shock, step on or stand on the toilet seat, toilet lid or top unit. Also do not place any heavy object on the toilet seat, toilet lid or top unit.

Doing so may cause cracking or cause the top unit to come loose and fall, resulting in injury. Doing so may damage the product and cause injury or water damage.

When maintaining the plastic parts (top unit etc.) or the water supply hose, use a pH neutral kitchen detergent diluted with water. Do not use any of the following.

Toilet cleaner, household cleaner, benzene, paint thinner, powdered cleanser or nylon scrubbing brush.

These items may damage or crack the plastic and cause injury or malfunction. These items could damage the water supply hose and cause a water leak.

To prevent a sudden water leak, do not remove the drain plug with water supply filter when the shutoff valve is open.

Doing so will cause water to spurt out. (→Refer to Page 54 for instructions on cleaning the drain plug with water supply filter.)

CAUTION

Do not fold or crush the water supply hose; do not damage by cutting with a sharp object.

Doing so may cause water leaks.

Do not pour hot water into the toilet.

Doing so may result in damage to the toilet, injury or water damage.

Keep the bowl filled with water.

Failure to do so may cause sewer gas, chlorine gas, or hydrogen sulfide to corrode facilities and equipment.

Do not flush anything other than bodily waste and toilet paper. Also, do not flush too much toilet paper. Do not flush the bowl unit if it is clogged.

Doing so may clog the toilet, causing waste water overflow, and water damage.

Always flush, even after just urinating.

Failure to do so may clog the toilet, causing waste water overflow and water damage or inadequate flushing of the bowl unit.

Wipe condensation on the bowl unit, tank, water supply pipe and shutoff valve with a dry cloth.

Condensation may cause staining and corrosion of the floor. Ventilate the restroom to prevent condensation.

Wipe any urine, condensation, cleaner, water, etc. that has gotten on the floor with a well-wrung mop or cloth.

Failure to do so may cause staining and corrosion of the floor.

If a water leak should occur, always close the shutoff valve.

When the ambient temperature is likely to drop to 32 °F (0 °C) or lower, prevent damage to the pipes and hoses due to freezing.

Frozen water pipes could cause the top unit and the pipes to break, resulting in a water leak. Regulate the room temperature to prevent the pipes and hoses from freezing during cold months.

When not using the product for a long time, close the shutoff valve, drain the water from the top unit and water supply hose, and then turn the power OFF.*1

When using the product again, allow the product to refill with water first. Otherwise, the water in the tank might become contaminated and cause skin inflammation or other problems. (→Refer to Page 61 for instructions on replenishing the water.) Leaving the power on may cause fire or heat.

When installing the drain plug with water supply filter, make sure that it is securely tightened in its proper position.

Failure to securely tighten it may cause a water leak.

If the bowl is clogged, turn the power OFF*1 and remove the clog.

If the auto flush were allowed to function, it would make the wastewater in the bowl unit overflow and may result in water damage. Use commercially available tools that are made for unclogging the bowl unit to remove the clogging.

Make sure of the plus and minus signs on the batteries before inserting them.

Remove depleted batteries immediately.

When replacing the batteries:

- Replace both batteries with new ones.
- Use the same brand for both new batteries (any brand available).

Failure to do so may cause the batteries to leak fluid, generate heat, rupture, or ignite.

When the product is supposed not to be used for long time, remove the batteries from the remote control.

Failure to do so may cause the batteries to leak fluid.

*1 How to turn off the product (→Page 15)

Safety Precautions

⚠ DANGER

To reduce the risk of electrocution:

1. Do not use while bathing.
2. Do not place or store the product where it can fall or be pulled into a tub or sink.
3. Do not place in or drop into water or other liquid.
4. Do not reach for the product when it has fallen into water. Unplug it immediately.

⚠ WARNING

To reduce the risk of burns, electrocution, fire or injury to persons:

1. Close supervision is necessary when this product is used by, on, or near children or invalids.
2. Use this product only for its intended use as described in this manual. Do not use attachments not recommended by the manufacturer.
3. Never operate this product if it has a damaged cord or plug, is not working properly, has been dropped or damaged, or has been dropped in water. Return the product to a service center for examination and repair.
4. Keep the cord away from heated surfaces.
5. Never block the air openings on the product or place it on a soft surface, such as a bed or couch, where the air openings may be blocked. Keep the air openings free of lint, hair, and other similar items.

6. Never use while sleepy or drowsy.
7. Never drop or insert any object into any opening or hose.
8. Do not use outdoors. Do not operate where aerosol (spray) products are being used or where oxygen is being administered.
9. Connect this product to a properly grounded outlet only.
See "Grounding Instructions" in below.
10. The tank should be filled with water only.

- Servicing should be performed by an authorized service representative.
- This product is for household use.

Grounding Instructions

This product should be grounded. In the event of an electrical short circuit, grounding reduces the risk of electric shock by providing an escape wire for the electrical current.

This product is equipped with a cord having a grounding wire with a grounding plug.

The plug must be plugged into an outlet that is properly installed and grounded.

⚠ DANGER - Improper use of the grounding plug can result in a risk of electric shock.

If repair or replacement of the cord or plug is necessary, do not connect the grounding wire to either flat-head terminal.

Check with a qualified electrician or serviceman if the grounding wire instructions are not completely understood, or if in doubt as to whether the product is properly grounded.

SAVE THESE INSTRUCTIONS

Operational Precautions

About the built-in body sensor

The body sensor detects human movement.

The toilet lid opening or "Auto bowl CLEAN" operation may be triggered by someone outside the bathroom as the sensor detects human movement through the door or wall in front of the top unit.

The sensor may not detect properly depending on the bathroom layout, resulting in the toilet lid not opening automatically.

For someone small such as a child, the body sensor may not detect properly, resulting in the toilet lid not opening automatically.

When you are using the toilet in standing position, the length of time it takes for "Auto flushing" to complete or for the toilet lid or seat to close automatically depends on the bathroom layout, etc.

About the built-in seat sensor

When you sit on the toilet seat, the seat sensor turns ON, enabling you to use various features. (The deodorizer starts when the seat sensor makes a detection.)

A label indicating the position of the seat sensor is attached to the seat.

Detection by the sensor may be difficult when the toilet is used by someone small, such as a child, depending on how the person sits.

Sit on the seat with the label as a guide. (The label can be peeled off).

Sit down so that the seat sensor touches your skin directly. The seat sensor may not detect properly if there is a seat cover or clothing. If you use the booster seat for infants, the seat sensor may not detect properly, resulting in the toilet lid closing automatically during use. Turn "Auto open / close" OFF before use.

Water droplets collecting on the seat sensor may cause the top unit to malfunction. Be sure to wipe off any water droplets on the sensor.

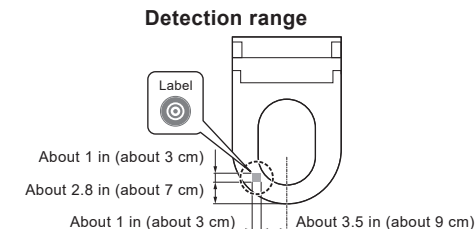

Operational Precautions

For prevention of damage

Wipe plastic areas such as the top unit and remote control with a soft cloth tightly wrung out with water.

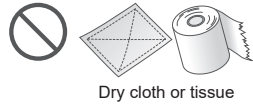

Do not lean against the toilet lid.



For prevention of malfunctions and failures

Do not block the remote control transmitter or receiver. May cause top unit to malfunction.

Turn the power OFF if there is a risk for lightning strike.*1

A toilet seat cover or a toilet lid cover cannot be used. Otherwise, the seat sensor may not detect properly. Additionally, the toilet seat and lid may not open or close properly.



Do not urinate on the top unit, toilet seat or wand. Doing so may cause a failure or discoloration.

Do not apply strong forces to the control panel of the remote control.

When using a toilet cleaner to clean the toilet, rinse it off within 3 minutes and leave the toilet seat and toilet lid open.

If vapor from a toilet cleaner enters the top unit, it may cause a malfunction.

► Wipe off any cleaner that remains on the bowl unit.

Note: If "Auto flush lid closed" (→ Pages 30, 31) is turned ON and you use the remote control to flush the bowl unit, the toilet seat and lid close before flushing the bowl unit. After the bowl unit has been flushed, open the toilet seat and lid.

Do not use the product with the toilet lid removed.

Do not expose to direct sunlight.

Doing so may cause changes in color, irregular heated seat temperature or remote control malfunction. It may also cause product malfunction due to the change in temperature.

Use radios, etc. away from the product.

The product could cause interference with the radio signal.

If you use a booster seat for infants or a soft highchair, remove it after use.

Keeping it installed may prevent some of the functions from being used.

Do not apply force to the remote control.

This cause malfunction.

► To prevent the remote control from being dropped, set it in the hanger when you are not using it. Be careful not to expose it to water.

Do not place anything on the toilet seat, and do not press them with hands.

Doing so may activate the seat sensor, causing the floor to get wet if buttons on the remote control are touched and warm water comes out from the wand.

Body Sensor Compliance

FEDERAL COMMUNICATIONS COMMISSION (FCC) INTERFERENCE STATEMENT

This equipment has been tested and found to comply with the limits for a Class B digital device, pursuant to part 15 of the FCC Rules. These limits are designed to provide reasonable protection against harmful interference in a residential installation. This equipment generates, uses and can radiate radio frequency energy and, if not installed and used in accordance with the instructions, may cause harmful interference to radio communications.

However, there is no guarantee that interference will not occur in a particular installation.

If this equipment does cause harmful interference to radio or television reception, which can be determined by turning the equipment off and on, the user is encouraged to try to correct the interference by one or more of the following measures:

- Reorient or relocate the receiving antenna.
- Increase the separation between the equipment and receiver.
- Connect the equipment into an outlet on a circuit different from that to which the receiver is connected.
- Consult the dealer or an experienced radio/TV technician for help.

CAUTION:

Any changes or modifications not expressly approved by the grantee of this device could void the user's authority to operate the equipment.

This device complies with part 15 of the FCC Rules.

Operation is subject to the following two conditions:

- (1) this device may not cause harmful interference, and
- (2) this device must accept any interference received, including interference that may cause undesired operation.

RF exposure warning

This equipment complies with FCC RF exposure limits set forth for an uncontrolled environment.

This equipment must not be co-located or operating in conjunction with any other antenna or transmitter.

Canada, Industry Canada (IC) Notices

This device complies with Industry Canada's licence-exempt RSSs.

Operation is subject to the following two conditions:

- (1) This device may not cause interference; and
- (2) This device must accept any interference, including interference that may cause undesired operation of the device.

Radio Frequency (RF) Exposure Information

The radiated output power of the Wireless Device is below the Industry Canada (IC) radio frequency exposure limits. The Wireless Device should be used in such a manner such that the potential for human contact during normal operation is minimized.

This device has also been evaluated and shown compliant with the IC RF Exposure limits under portable exposure conditions.

(antennas are less than 8 inch (20 cm) of a person's body).

*1 How to turn off the product (→Page 15)

Parts Names

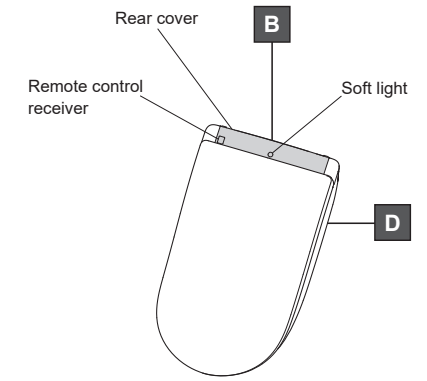
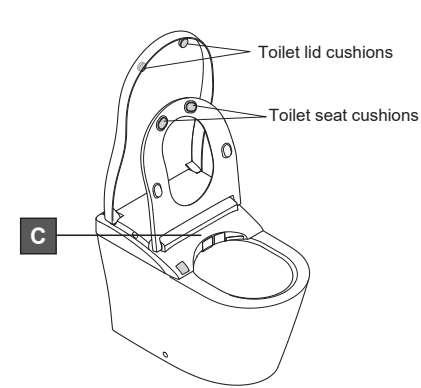
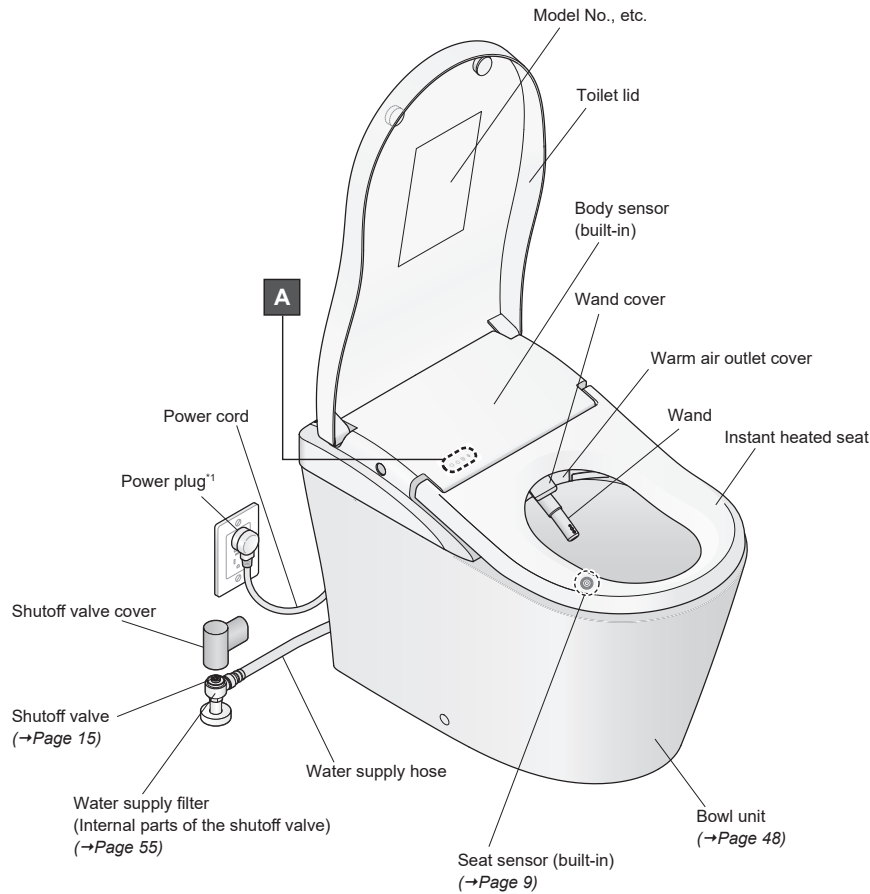

B : Rear side of the top unit

Manual water supply cord (orange) (→Pages 56,57)
Manual water storage cord (white) (→Pages 56,57)

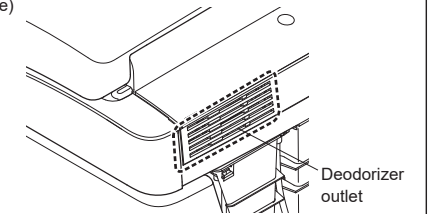
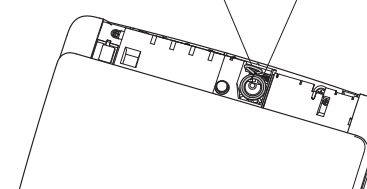
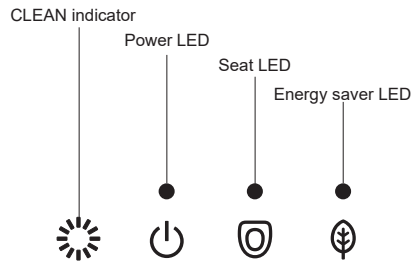

Illustration as seen from the right rear

A: Main display



All the CLEAN indicator and LEDs illuminate in the figure

C : Front side of the top unit

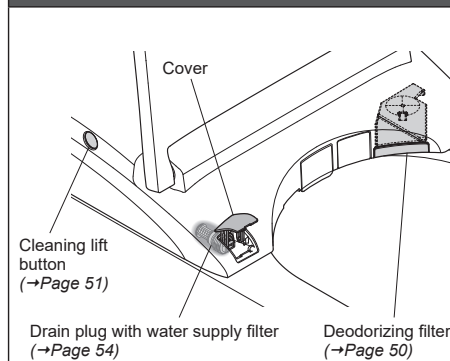

D : Right side of the top unit

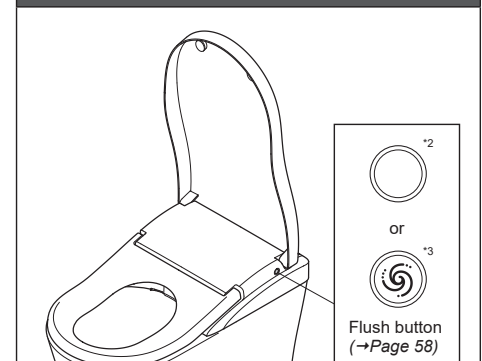

*1 The shape of the power plug may vary.

*2 For non-matte-colored products

*3 For matte-colored products

Preparation

Using the Product for the First Time

1. Insert the battery

1.1 Remove the remote control from the hanger.

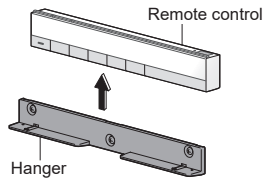

1.2 Open the battery cover and insert two AA batteries. Insert batteries and close the battery cover.

Remote control backside

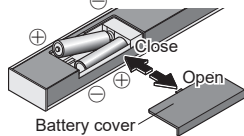

- ▶ When batteries are properly inserted, temperature levels appear on the display of the remote control (back side).

When the temperature levels are not displayed.
Perform step 3 of "Language Settings".
(→Page 40)

The display goes out when no button on the remote control is pressed for about 60 seconds or more.

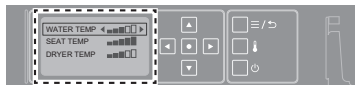

1.3 Mount the remote control in the hanger.

About the batteries

Use dry cell, alkaline batteries.

Be sure to follow "Safety Precautions" to prevent the batteries from rupturing or leaking fluid. (→Pages 4, 7)

If the remote control is secured to prevent theft

- 1) Remove the screw from the remote control fixture.
(2 pieces, left and right)

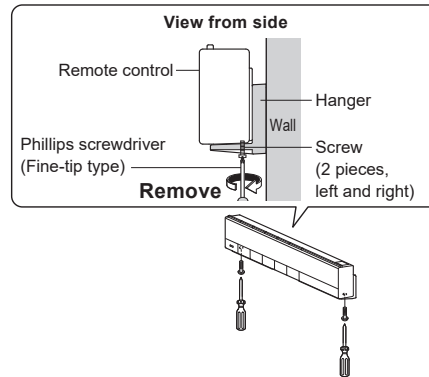

- 2) Remove the remote control from the hanger.

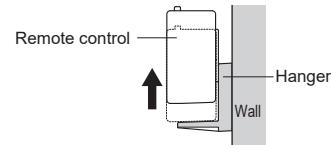

To secure the remote control again

Tighten two screws on the left and right to secure it.
Overtightening may cause damage to parts such as the hanger.

2. Turn on the power

2.1 Insert the power plug.

- ▶ The wand extends and then retracts.

2.2 Check the "Power" LED illuminates.

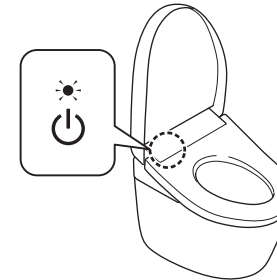

If the light is off

Switch "Power" to "ON" using the remote control.

To operate from the back of remote control

- 1)
Press "Power ON/OFF" button about 3 seconds or longer.

To operate from the front of remote control

Recommended if the remote control is secured to prevent theft, etc.

- 1) and
Press the "Stop" button and "Water pressure adjustment +" button at the same time for about 10 seconds or longer.

To turn the power "OFF"

Unplug the power plug.

- ▶ The "Power" LED is unilluminated.

3. Open the shutoff valve

3.1 Remove the shutoff valve cover.

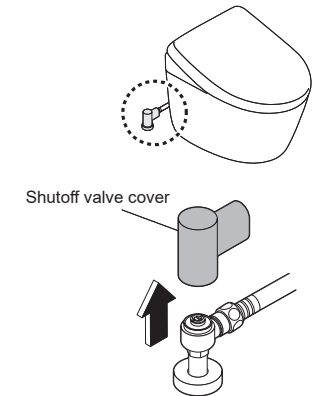

3.2 Fully open the shutoff valve.

Opening / closing tool (accessory)*¹
or flat-head screwdriver

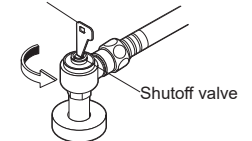

3.3 Install the shutoff valve cover.

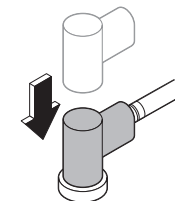

*1 Use the supplied opening/closing tool.

Basic Operations

Mechanism of Auto Functions

"EWATER+" is used automatically to clean the wand, bowl unit and under the seat.

1. As you approach



Auto open / close
Auto bowl CLEAN
Instant heated seat

Auto open / close

The toilet lid opens



When the toilet is used in standing position

Open the toilet seat with the remote control.

Auto bowl CLEAN

PREMIST - Mist spray with water



The Bowl light lights up

A mist is automatically sprayed inside the bowl unit to make it more difficult for dirt to adhere.

Instant heated seat



Warming starts from the standby temperature.

2. As you sit*1



Deodorizer
Instant heated seat

Deodorizer

Starts the deodorizer



Removing odors inside the bowl unit.

Note: Deodorizing filter needs regular maintenance. (→Page 50)

Instant heated seat



Warms to the set temperature

3. As you stand up



Auto power deodorizer
Auto flushing
Auto wand CLEAN

Auto power deodorizer

After about 10 seconds

Starts the auto power deodorizer



It stops about 60 seconds after you stand up from the toilet seat

Auto flushing

After about 10 seconds

The toilet flushes*2



Note: The flushing varies depending on how long you sit on the toilet seat.

- Performs a light flush if the time is about 6 to 30 seconds.
- Performs a full flush if the time is about 30 seconds or longer.

Auto wand CLEAN

Only when the washing functions are used

After about 25 seconds

The wand extends to clean with the "EWATER+" that comes out of the base*3



The Bowl light lights up

Note: "EWATER+" can also be used by pressing the remote control button. (→Page 20 "Wand CLEAN")

4. As you move away

When you move away



Auto flushing
Auto open / close
Auto bowl CLEAN
Auto underseat CLEAN
Instant heated seat

When the toilet is used in standing position

Auto flushing

The toilet flushes*2



Performs a light flush.

Auto open / close

The toilet lid and toilet seat close*2



Auto bowl CLEAN
Auto underseat CLEAN

When you move away

EWATER+ mist*4



The Bowl light lights up

EWATER+ mist is sprayed on the bowl unit and underneath the front of the toilet seat.*5

Note: "EWATER+" can also be used by pressing the remote control button. (→Page 50 "Manual Spray")

Auto open / close*6

The toilet lid closes*2



Instant heated seat



Returns to the standby temperature

Operation under the default settings is described in "Mechanism of Auto Functions".

These mechanisms be changed. (→Pages 26-45 "Changing Settings")

What is meant by "EWATER+" ?

"EWATER+" helps the self-cleaning features work effectively and by preventing the accumulation of dirt that can cause stains.

- "EWATER+" is generated from chemicals already present in potable water.
- "EWATER+" helps to minimize dirty surfaces, but does not make cleaning unnecessary.
- The effect of rinsing with "EWATER+" can vary depending on the frequency of toilet use and other conditions.

*1 Water comes out from the area around the wand for several seconds while water is warmed up.

*2 You can change to the setting that closes the toilet lid before flushing the bowl unit. (→Pages 30, 31)

*3 When the washing functions (Rear washing and Front washing etc.) have not been used in 8 hours, the wand is cleaned automatically. (Water comes out from around the wand.)

*4 Mist is sprayed on the bowl unit and underneath the front of the toilet seat that gets dirty easily. If the toilet lid is closed, it is opened to spray mist. (If you do not want to open the toilet lid when spraying mist) (→Page 68)

*5 When the washing feature (Rear washing and Front washing etc.) is not used for about 8 hours, mist is sprayed on the bowl unit automatically.

*6 When you do not sit on the toilet seat, or when you sit on it or stand in front of the bowl unit briefly, it takes about 5 minutes before the lid closes automatically.

Basic Operations

Mechanism of Auto Functions

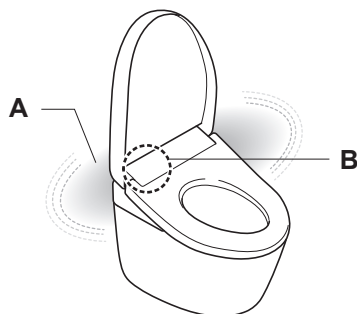

A Soft light

Lighting up the inside of the bathroom with a soft light.

It lights up as you approach the bowl unit and goes off after you move away from the unit and a certain time has passed.

Note: You can turn "Soft light" ON or OFF. (→Page 39)

Night light

You can change "Soft light" and "Bowl light" to "Night mode", a lighting mode suitable for night. (→Page 38)

B CLEAN indicator

Lights to show that the "Auto bowl CLEAN", "Auto underseat CLEAN", "Deodorizer", "Auto wand CLEAN", and "Manual spray" functions are operating.

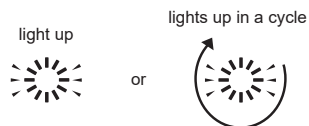





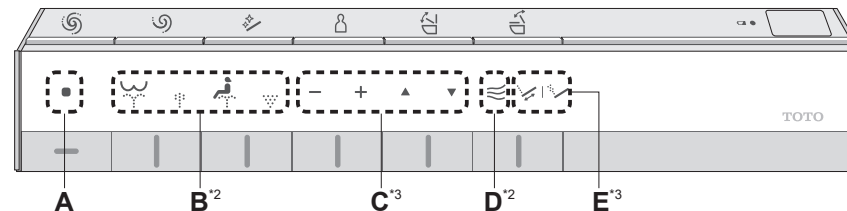

Lights only when the toilet seat is not in-use*1

Note: You can turn "CLEAN indicator" ON or OFF. (→Page 40)

Using the Remote Control





Operate the controls on the remote control; a beep sounds when the top unit receives the signal.

- A**  **Stop**
Stops the B or D operation.
- B**  **Rear washing**
Washes your rear.
 **Rear soft washing**
Washes your rear with soft embracing water flow.
-  **Front washing**
Serves as a bidet for ladies.
 **Wide front washing**
Gently washes a wide area.
- C**  **Water pressure adjustment**
You can adjust the water pressure to one of five levels.
[-] Softer, [+] Stronger
-  **Wand position adjustment**
You can adjust the washing position to 5 different points between the front and the rear, using the [▲] and [▼] buttons.

Once use of the remote control is finished, the settings will return to the initial setting (3rd position) after a while, not exceeding a maximum of 5 minutes.

If you do not want to return to 3rd position (→Page 43)

Note: Sitting back on the toilet seat makes it easier to adjust the wand position and to reduce splashing.

- D**  **Warm air drying**
Dries your rear.
- E**  **Oscillating washing**
The wand moves back and forth to washes your rear thoroughly.
 **Pulsating washing**
Washes with the water pressure pulsating between soft and strong.

The washing mode changes each time you press the button.

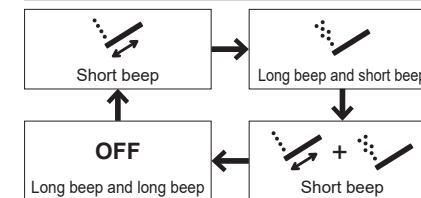

Note: Sitting back on the toilet seat makes it easier to adjust the wand position and to reduce splashing.

*1 Except "Manual spray"

*2 This cannot be used if the seat sensor is not working. Sit down so that the seat sensor touches your skin directly. (→Page 9)

*3 While using B, these buttons and their functions can be operated.

Basic Operations

Using the Remote Control (Continued)

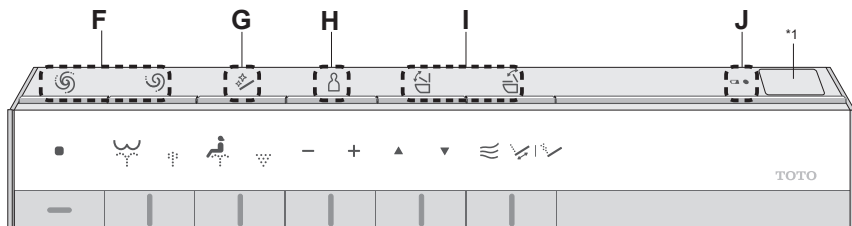

Operate the controls on the remote control; a beep sounds when the top unit receives the signal.

F **Full flush**^{*2}
 Performs a full flush.
 Up to 33 ft (10 m) of toilet paper (single)

Light flush^{*2}
 Performs a light flush.
 Up to 10 ft (3 m) of toilet paper (single)

G **Wand CLEAN**
 Cleans the wand with "EWATER+"^{*3}
 After wand cleaning, water comes out from around the wand.

Note: This function will operate automatically after using the washing functions (Rear washing, Front washing, etc.). (→Pages 17, 35 "Auto wand CLEAN")

Note: To clean the wand with it extended. (→Page 53 "Wand cleaning")

H **Personal setting**

Up to four people can register their preferred "Water pressure", "Wand position" and "Warm water temperature" settings. (→Pages 43, 44)

To use

- 1) Press the button and check the beep sound to select the register number.
 REGISTER1: One short beep
 REGISTER2: Two short beeps
 REGISTER3: Three short beeps
 REGISTER4: Four short beeps
- 2) Press the wash button you want to use ("Rear washing", etc.)

I **Opening and closing the toilet lid**
 Opens and closes the toilet lid.

Opening and closing the toilet seat
 Opens and closes the toilet seat.

J **Low battery warning LED**
 (→Page 58)

Remote control back side

How to remove the remote control (→Page 14)

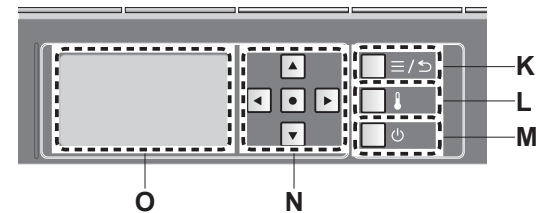

K **"Menu, Return" button**
 Adjust settings
 Return to the previous menu

L **"Temperature adjustment" button**
 Adjust temperatures
 (→Pages 24, 25)

M **"Power ON/OFF" button**
 Pressing it about 3 seconds or longer turns the power on/off.
 ► If the remote control is secured to prevent theft (→Page 15 2-2.2)

N **SELECT keys**
 Select settings.

Enter button

O **Display screen**

*1 Remote control transmitter

*2 You can change to the setting that closes the toilet lid before flushing the bowl unit. (→Pages 30, 31)

*3 What is meant by "EWATER+" ? (→Page 17)

Basic Operations

About the Menu Screen

This section is an overview of the settings that can be configured with the remote control. See the corresponding pages for the detailed descriptions.

Remote control back side

How to remove the remote control (→Page 14)

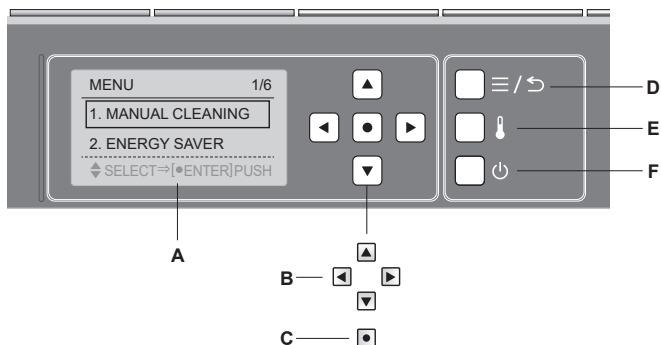

A Display screen

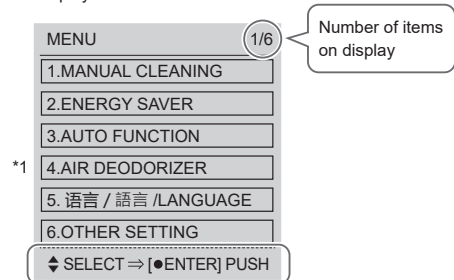

The next step is shown at the bottom of the display screen.

B SELECT keys
Select a setting

C Enter button

D "Menu, Return" button

E "Temperature adjustment" button (→Pages 24, 25)

F "Power ON/OFF" button
Pressing it about 3 seconds or longer turns the power on/off.

1. Press the "Menu, Return" button.

▶ The display screen changes.

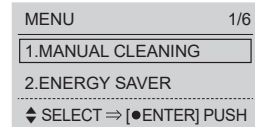

2. Set the item from the display screen.

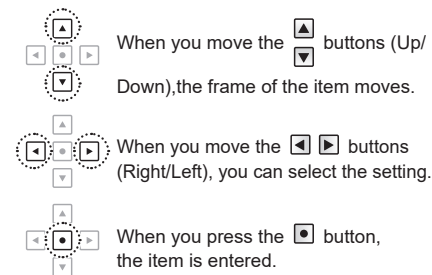

*1 [AIR DEODORIZER] is displayed but cannot be set.

You can set as desired

If you want to return to the previous item, press the button.

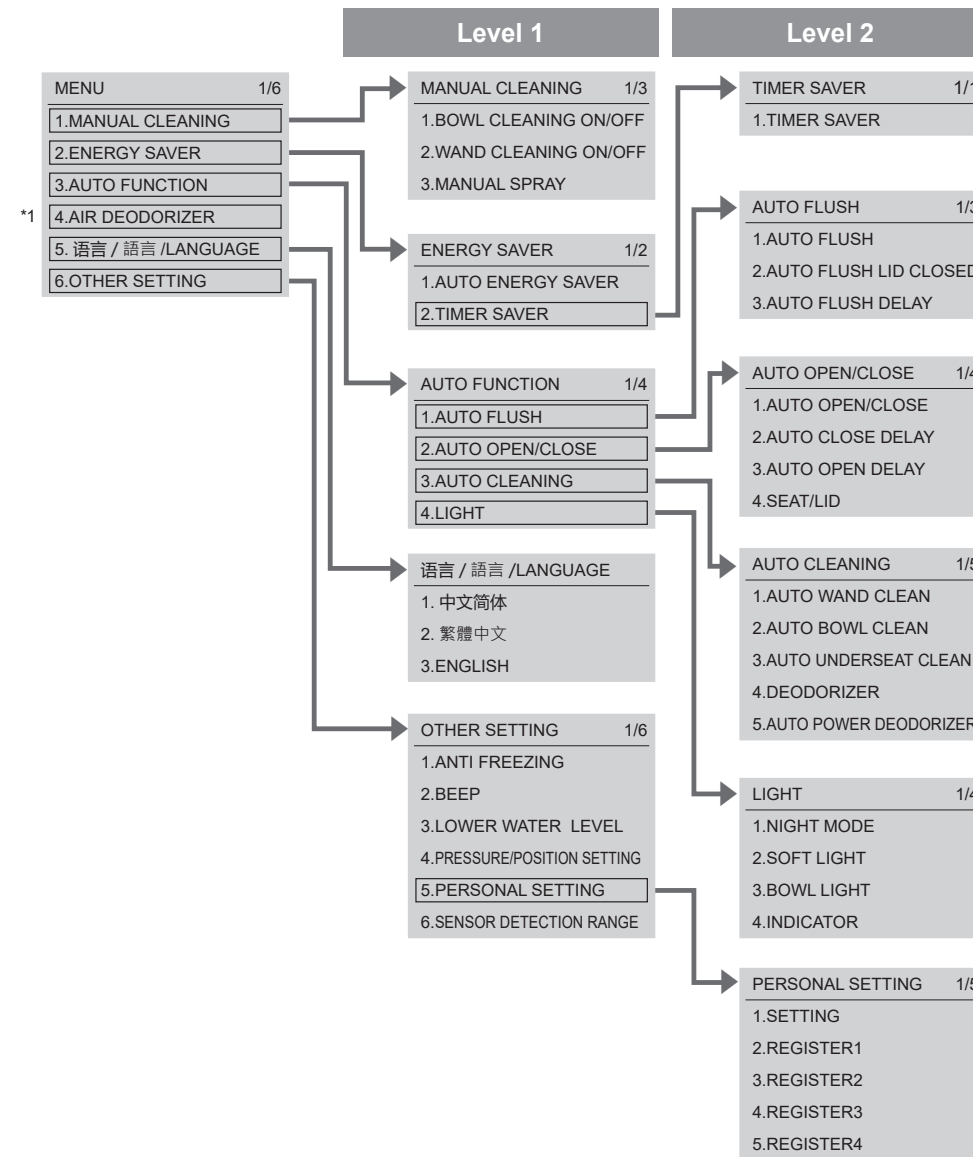

Temperature Adjustment

Warm Water, Toilet Seat, Drying

Five different temperature levels from high to low and "OFF" can be set.

Remote control back side

How to remove the remote control (→Page 14)

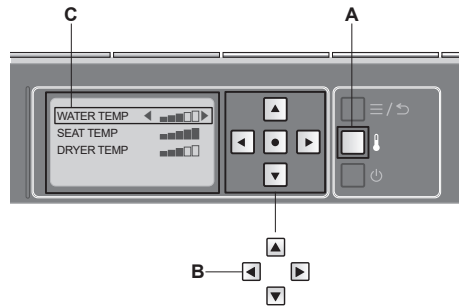

- A "Temperature adjustment" button
- B SELECT keys
Select a setting
- C Displays the temperature level

Note: During setting, the display goes out when no button is pressed within about 60 seconds.
If you fail to complete the setting, redo from the step 1.

Warm water temperature

1. Press the "Temperature adjustment" button.
2. Use the "SELECT keys" to select [WATER TEMP].

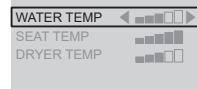

3. Use the "SELECT keys" to select the temperature level.
WATER TEMP OFF ↔ Low ↔ High^{*1}

Note: If you want to turn it OFF, press the SELECT key until [OFF] appears

Settings complete

Toilet seat temperature

1. Press the "Temperature adjustment" button.
2. Use the "SELECT keys" to select [SEAT TEMP].

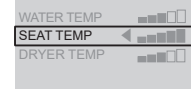

3. Use the "SELECT keys" to select the temperature level.
SEAT TEMP OFF ↔ Low ↔ High

Note: If you want to turn it OFF, press the SELECT key until [OFF] appears.

▶ When seat temperature is OFF, the seat LED is unilluminated.

Settings complete

If adjusting the temperature does not warm up the toilet seat.

▶ Is the energy saver set to "ON"? (→Page 28)

Drying air temperature

1. Press the "Temperature adjustment" button.
2. Use the "SELECT keys" to select [DRYER TEMP].

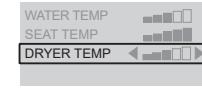

3. Use the "SELECT keys" to select the temperature level.
DRYER TEMP Low ↔ High

Note: The "Drying" cannot be turned "OFF".

Settings complete

*1 To prevent condensation, the water temperature does not drop below 68 °F (20 °C) even when set to "OFF".

Changing Settings

Setting List

Setting Types	Available Settings Bold: Initial settings
Auto energy saver+ (→Page 29)	ON/OFF
Timer energy saver (→Page 29)	6H/9H/OFF
Auto flushing (→Page 30)	ON/OFF
Auto flush lid closed (→Page 30)	ON/OFF
Auto flush delay (→Page 32)	SET1/SET2/SET3
Auto open / close (→Page 32)	ON/OFF
Auto close delay (→Page 33)	SET1/SET2
Auto open delay (→Page 34)	SET1/SET2/SET3
Seat/lid (→Page 34)	Lid/Seat-Lid
Auto wand CLEAN (→Page 35)	ON/OFF
Auto bowl CLEAN (→Page 36)	ON/OFF
Auto underseat CLEAN (→Page 36)	ON/OFF
Deodorizer (→Page 37)	ON/OFF
Auto power deodorizer (→Page 37)	ON/OFF
Night light (→Page 38)	ON/STANDBY/TIMER
Soft light (→Page 39)	ON/OFF
Bowl light (→Page 39)	ON/OFF
CLEAN indicator (→Page 40)	ON/OFF
Language settings (→Page 40)	Simplified Chinese/Traditional Chinese/English
Anti freezing (→Page 41)	ON/OFF
Beep sound (→Page 42)	ON/OFF
Lower water level (→Page 42)	-
Pressure/position setting (→Page 43)	ON/OFF
Personal setting (→Page 43)	ON/OFF
Registering Personal Settings (→Page 44)	Register 1/Register 2/Register 3/Register 4
Sensor detection range (→Page 45)	SET1/SET2/SET3/SET4/SET5

Setting with buttons on the back of the remote control.

Remote control back side

How to remove the remote control (→Page 14)

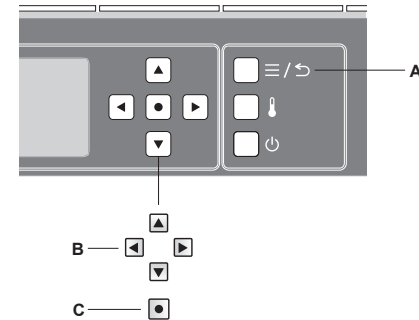

- A "Menu, Return" button
- B SELECT keys
- C Enter button

Note: During setting, the display goes out when no button is pressed within about 60 seconds.
If you fail to complete the setting, redo from the step 1.

Changing Settings

The energy saver features

"Auto energy saver+" or "Timer energy saver" can be selected. You can save energy by turning the toilet seat heater "OFF".

Note: Even if the energy saver feature is on (i.e., the toilet seat heater is "OFF"), the seat temporarily becomes warm when approaching the bowl unit or when sitting on the toilet seat. (It takes about 60 seconds to reach the setting temperature.)

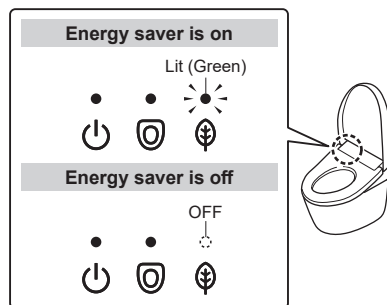

Auto energy saver+

You want the product to save energy automatically.

The product detects time periods with no use and turns the toilet seat heater OFF automatically.

"Auto energy saver+" takes about 10 days to detect time periods in which the toilet seat is never used.

Example

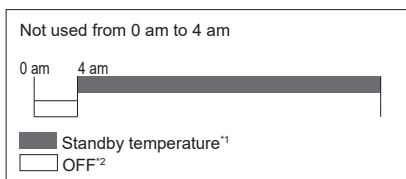

Timer energy saver and Auto energy saver+

You want to save more energy.

When both "timer energy saver" and "Auto energy saver+" are set, "Auto energy saver+" operates when "timer energy saver" is not operating.

Example

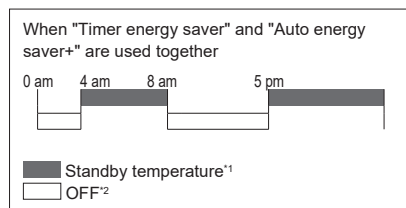

Timer energy saver

You want to save energy only for a preset duration of time. (6 hours, 9 hours)

Once the time is set, the toilet seat heater turns off automatically during the set time period every day.

Example

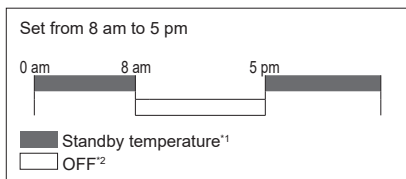

*1 The time period when the toilet seat heater is set to a "standby temperature".

*2 The time period when the toilet seat heater is set to a "OFF".

How to Set

Auto energy saver+

1. Press the "Menu, Return" button.

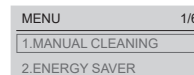

2. Use the "SELECT keys" to select [ENERGY SAVER].

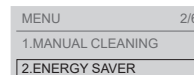

- Press the "Enter" button.

3. Use the "SELECT keys" to select [AUTO ENERGY SAVER].

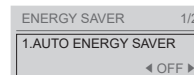

4. Use the "SELECT keys" to select [AUTO ENERGY SAVER+].^{*3}

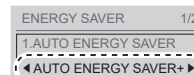

- Press the "Enter" button.

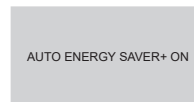

(To return)

Timer energy saver

Set the "Timer energy saver" at the time you want to start it

Example: To save energy from 1 am to 7 am (for 6 hours)

1. Press the "Menu, Return" button.

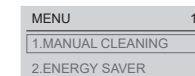

2. Use the "SELECT keys" to select [ENERGY SAVER].

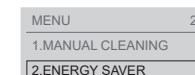

- Press the "Enter" button.

3. Use the "SELECT keys" to select [TIMER SAVER].

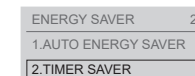

- Press the "Enter" button.

4. Use the "SELECT keys" to select [6H], [9H], or [OFF].

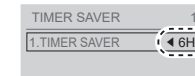

- Press the "Enter" button.

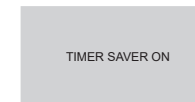

(To return)

To change the timer energy saver time

▶ Set the timer energy saver again at the time you want to start it.

*3 [AUTO ENERGY SAVER] is displayed but cannot be set.

Changing Settings

Auto flushing

Set whether or not to clean the bowl unit automatically

1. Press the "Menu, Return" button.

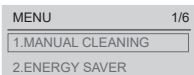

2. Use the "SELECT keys" to select [AUTO FUNCTION].

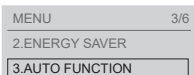

- Press the "Enter" button.

3. Use the "SELECT keys" to select [AUTO FLUSH].

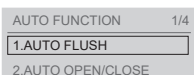

- Press the "Enter" button.

4. Use the "SELECT keys" to select [AUTO FLUSH].



5. Use the "SELECT keys" to select [ON] or [OFF].

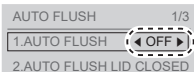

- Press the "Enter" button.

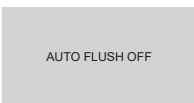

(To return)

Auto flush lid closed

Set whether or not to close the toilet lid automatically before flushing the bowl unit

1. Press the "Menu, Return" button.

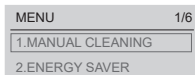

2. Use the "SELECT keys" to select [AUTO FUNCTION].

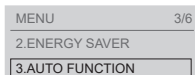

- Press the "Enter" button.

3. Use the "SELECT keys" to select [AUTO FLUSH].



- Press the "Enter" button.

4. Use the "SELECT keys" to select [AUTO FLUSH LID CLOSED].

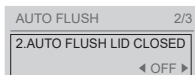

5. Use the "SELECT keys" to select [ON] or [OFF].



- Press the "Enter" button.

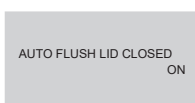

(To return)

About "Auto flush lid closed"...

About 10 seconds after you stand up or move away if you use the toilet in standing position, the toilet lid closes automatically before flushing the bowl unit.

Also, if you press the Flush buttons ("Full flush" or "Light flush") on the remote control, the toilet lid closes before flushing the bowl unit.

Using the toilet seat



Stand up

The toilet lid closes in about 10 seconds.
▶ The toilet lid closes before flushing the bowl unit.

Using the toilet in standing position



Move away

The toilet seat and lid close when you move away.
▶ The toilet seat and lid close before flushing the bowl unit.*1

Using the flush buttons on the remote control



The toilet lid closes.
▶ The toilet lid closes before flushing the bowl unit.

"Auto flush lid closed" does not work if "Auto flushing" and "Auto open / close" are set as below: (Except when using the Flush buttons on the remote control)

	Auto flushing	Auto open / close
1)	OFF	ON
2)	ON	OFF
3)	OFF	OFF

- 1) The toilet lid closes automatically but the bowl unit does not flush.
- 2) The bowl unit flushes automatically but the toilet lid does not close.
- 3) The toilet lid does not open / close and the bowl unit does not flush automatically.

Turn both "Auto flushing" and "Auto open / close" ON. (→Pages 30, 32)

Even if "Auto flushing" is turned ON, "Auto flush lid closed" may not work in some cases. For details, refer to "Auto flush lid closed" does not work" in "Troubleshooting". (→Page 70)

Note: You can change the length of time before water flushes after closing the toilet lid automatically to [SET 1], [SET 2], or [SET 3]. (→Page 32)

If you get up slightly from the seat or sit leftward on the seat while seated on it, the seat sensor may not detect properly, which results in the toilet lid being closed and bowl unit being flushed. Sit down so that the seat sensor touches your skin directly. (→Page 9)

While using the toilet in standing position, the toilet lid may close and the bowl unit may be flushed. Stand straight in front of the bowl unit.

*1 The toilet seat and lid close in about 30 seconds and then the bowl unit flushes.

Changing Settings

Auto flush delay^{*1*2}

Change the amount of time before the toilet flushes automatically

1. Press the "Menu, Return" button.

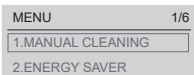

2. Use the "SELECT keys" to select [AUTO FUNCTION].

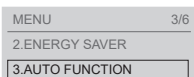

- Press the "Enter" button.

3. Use the "SELECT keys" to select [AUTO FLUSH].

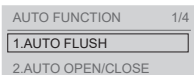

- Press the "Enter" button.

4. Use the "SELECT keys" to select [AUTO FLUSH DELAY].



5. Use the SELECT keys to select [SET 1], [SET 2], or [SET 3].



SET 1 (Short) : After about 5 seconds
SET 2 (Standard): After about 10 seconds
SET 3 (Long) : After about 15 seconds

If "Auto flush lid closed" is turned ON, the toilet lid closes before flushing the bowl unit as above.

- Press the "Enter" button.



(To return)

Auto open / close

Set whether or not to open and close the toilet lid automatically

1. Press the "Menu, Return" button.

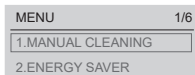

2. Use the "SELECT keys" to select [AUTO FUNCTION].

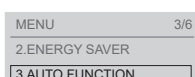

- Press the "Enter" button.

3. Use the "SELECT keys" to select [AUTO OPEN / CLOSE].

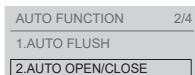

- Press the "Enter" button.

4. Use the "SELECT keys" to select [AUTO OPEN / CLOSE].

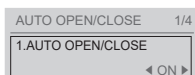

5. Use the "SELECT keys" to select [ON] or [OFF].^{*3}

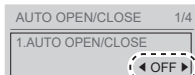

- Press the "Enter" button.

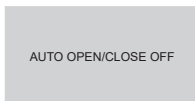

(To return)

Auto close delay^{*4*5}

Change the amount of time before the lid/seat closes automatically

1. Press the "Menu, Return" button.

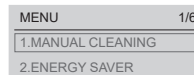

2. Use the "SELECT keys" to select [AUTO FUNCTION].

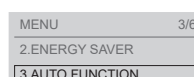

- Press the "Enter" button.

3. Use the "SELECT keys" to select [AUTO OPEN / CLOSE].

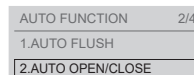

- Press the "Enter" button.

4. Use the "SELECT keys" to select [AUTO CLOSE DELAY].

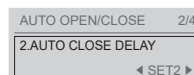

5. Use the "SELECT keys" to select [SET 1] or [SET 2].⁶



SET 1 (Short) : After about 25 seconds
SET 2 (Standard): After about 90 seconds

- Press the "Enter" button.

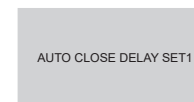

(To return)

*1 This operation cannot be performed if "Auto flushing" is turned OFF.

*2 The length of time specified for "Auto close delay (Auto flush lid closed)" if "Auto flush lid closed" is turned ON.

*3 Even if this function is turned OFF, the toilet lid opens before spraying mist for "Auto underseat CLEAN" and closes after completion. (If you do not want to open the toilet lid when spraying mist. →Page 68)

*4 This operation cannot be performed if "Auto open / close" is turned OFF.

*5 If "Auto flush lid closed" is turned ON, you cannot use this setting to change the length of time before closing the toilet lid automatically. Configure the settings for "Auto flush delay". (→Page 32)

*6 When set to [SET 1], the lid/seat does not open automatically for about 15 seconds after closing automatically.

Changing Settings

Auto open delay*1

Change the time period till automatic opening
(After closing by hand or remote control.)

1. Press the "Menu, Return" button.

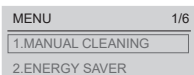

2. Use the "SELECT keys" to select [AUTO FUNCTION].

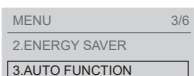

- Press the "Enter" button.

3. Use the "SELECT keys" to select [AUTO OPEN / CLOSE].

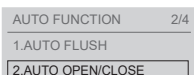

- Press the "Enter" button.

4. Use the "SELECT keys" to select [AUTO OPEN DELAY].

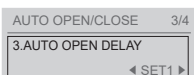

5. Use the "SELECT keys" to select [SET1], [SET2], or [SET3].

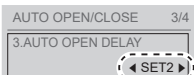

SET 1 (Short) : After about 15 seconds
SET 2 (Middle) : After about 30 seconds
SET 3 (Long) : After about 90 seconds

- Press the "Enter" button.

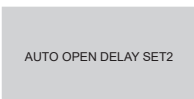

(To return)

Seat/lid*1

Automatically open and close the toilet lid/
Automatically open and close the toilet seat
and toilet lid

1. Press the "Menu, Return" button.

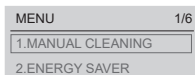

2. Use the "SELECT keys" to select [AUTO FUNCTION].

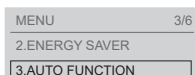

- Press the "Enter" button.

3. Use the "SELECT keys" to select [AUTO OPEN / CLOSE].

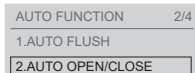

- Press the "Enter" button.

4. Use the "SELECT keys" to select [SEAT / LID].

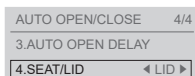

5. Use the "SELECT keys" to select [LID] or [SEAT · LID].*2*3

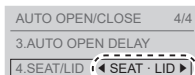

- Press the "Enter" button.

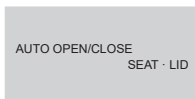

(To return)

Auto wand CLEAN

Set whether or not to clean the wand automatically

1. Press the "Menu, Return" button.

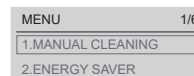

2. Use the "SELECT keys" to select [AUTO FUNCTION].

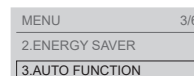

- Press the "Enter" button.

3. Use the "SELECT keys" to select [AUTO CLEANING].

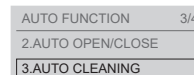

- Press the "Enter" button.

4. Use the "SELECT keys" to select [AUTO WAND CLEAN].

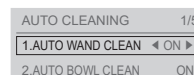

5. Use the "SELECT keys" to select [ON] or [OFF].

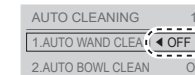

- Press the "Enter" button.

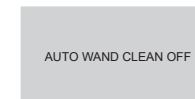

(To return)

*1 This operation cannot be performed if "Auto open / close" is turned OFF.

*2 When the [SEAT · LID] are set to open automatically, PREMIST is not sprayed.

*3 When [SEAT · LID] are set, a light flush may be performed even if you do not stand and use it, depending on the layout of your toilet.

Changing Settings

Auto bowl CLEAN*1

Set whether or not to spray mist in the bowl unit automatically

1. Press the "Menu, Return" button.

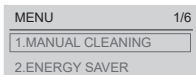

2. Use the "SELECT keys" to select [AUTO FUNCTION].

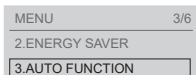

- Press the "Enter" button.

3. Use the "SELECT keys" to select [AUTO CLEANING].

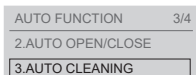

- Press the "Enter" button.

4. Use the "SELECT keys" to select [AUTO BOWL CLEAN].

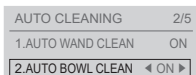

5. Use the "SELECT keys" to select [ON] or [OFF].

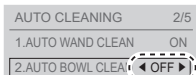

- Press the "Enter" button.

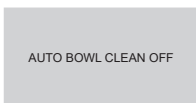

(To return Press the "Menu, Return" button.)

Auto underseat CLEAN*1

Set whether or not to spray mist to the back of the toilet seat automatically

1. Press the "Menu, Return" button.

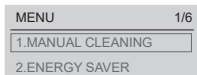

2. Use the "SELECT keys" to select [AUTO FUNCTION].

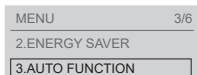

- Press the "Enter" button.

3. Use the "SELECT keys" to select [AUTO CLEANING].

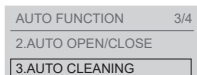

- Press the "Enter" button.

4. Use the "SELECT keys" to select [AUTO UNDERSEAT CLEAN].

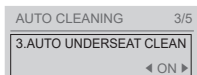

5. Use the "SELECT keys" to select [ON] or [OFF].

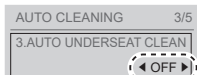

- Press the "Enter" button.

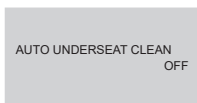

(To return Press the "Menu, Return" button.)

Deodorizer

Set whether or not to deodorize automatically after sitting on the toilet seat

1. Press the "Menu, Return" button.

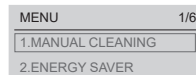

2. Use the "SELECT keys" to select [AUTO FUNCTION].

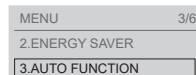

- Press the "Enter" button.

3. Use the "SELECT keys" to select [AUTO CLEANING].

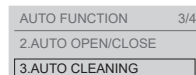

- Press the "Enter" button.

4. Use the "SELECT keys" to select [DEODORIZER].

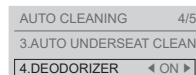

5. Use the "SELECT keys" to select [ON] or [OFF].

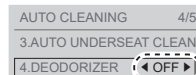

- Press the "Enter" button.

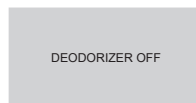

(To return Press the "Menu, Return" button.)

Auto power deodorizer

Set whether or not to power deodorize automatically after standing up

1. Press the "Menu, Return" button.

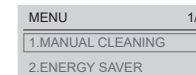

2. Use the "SELECT keys" to select [AUTO FUNCTION].

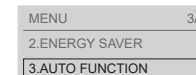

- Press the "Enter" button.

3. Use the "SELECT keys" to select [AUTO CLEANING].

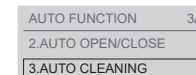

- Press the "Enter" button.

4. Use the "SELECT keys" to select [AUTO POWER DEODORIZER].

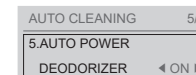

5. Use the "SELECT keys" to select [ON] or [OFF].

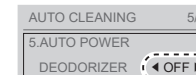

- Press the "Enter" button.

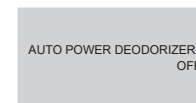

(To return Press the "Menu, Return" button.)

*1 If "Auto bowl CLEAN" is turned OFF, the mist for "Auto underseat CLEAN" is not sprayed.

Changing Settings

Night light

Set whether or not to change "Soft light" and "Bowl light" to "Night mode", a lighting mode suitable for night, as well as the time window.

To set the time window (timer), set the desired start time.

1. Press the "Menu, Return" button.

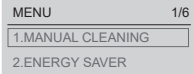

2. Use the "SELECT keys" to select [AUTO FUNCTION].

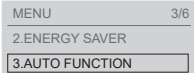

- Press the "Enter" button.

3. Use the "SELECT keys" to select [LIGHT].

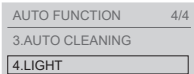

- Press the "Enter" button.

4. Use the "SELECT keys" to select [NIGHT MODE].



5. Use the "SELECT keys" to select [ON], [STANDBY], or [TIMER].



- Press the "Enter" button.

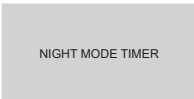

(To return Press the "Menu, Return" button.)

About "Night light"...

You can change "Soft light" and "Bowl light" to "Night mode", a lighting mode suitable for night.

Note: The light does not turn on if "Soft light" and "Bowl light" are turned OFF.

The "Night light" is turned ON

Soft light

Lights permanently



Bowl light

Lights up only while someone is detected



The brightness changes according to human movement.

The "Night light" is turned OFF [STANDBY]

Soft light

Lights up as specified in the settings



Bowl light

Lights up as specified in the settings



The "Night light" is configured with the timer



The light turns ON / OFF [STANDBY] every 12 hours starting from the set time.

Example

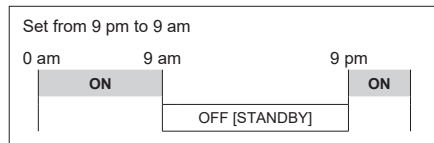

Soft light

Set whether or not to use the soft light

1. Press the "Menu, Return" button.

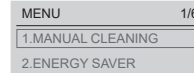

2. Use the "SELECT keys" to select [AUTO FUNCTION].

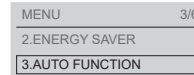

- Press the "Enter" button.

3. Use the "SELECT keys" to select [LIGHT].

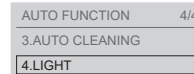

- Press the "Enter" button.

4. Use the "SELECT keys" to select [SOFT LIGHT].



5. Use the "SELECT keys" to select [ON] or [OFF].

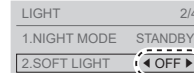

- Press the "Enter" button.



(To return Press the "Menu, Return" button.)

Bowl light

Set whether or not to use the light inside the bowl unit

1. Press the "Menu, Return" button.

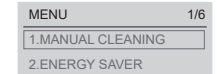

2. Use the "SELECT keys" to select [AUTO FUNCTION].

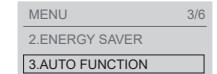

- Press the "Enter" button.

3. Use the "SELECT keys" to select [LIGHT].

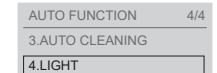

- Press the "Enter" button.

4. Use the "SELECT keys" to select [BOWL LIGHT].



5. Use the "SELECT keys" to select [ON] or [OFF].



- Press the "Enter" button.

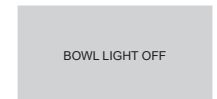

(To return Press the "Menu, Return" button.)



Changing Settings

CLEAN indicator

Set whether or not to light up the CLEAN indicator

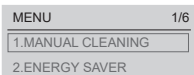

1.  Press the "Menu, Return" button.

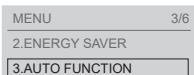

2.  Use the "SELECT keys" to select [AUTO FUNCTION].



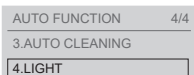

-  Press the "Enter" button.

3.  Use the "SELECT keys" to select [LIGHT].





-  Press the "Enter" button.

4.  Use the "SELECT keys" to select [INDICATOR].



-  Press the "Enter" button.

5.   Use the "SELECT keys" to select [ON] or [OFF].



-  Press the "Enter" button.

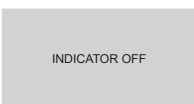



(To return )

Language settings

Select the language displayed on the back of remote control

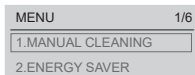

1.  Press the "Menu, Return" button.

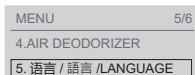

2.  Use the "SELECT keys" to select [语言 / 語言 / LANGUAGE].



-  Press the "Enter" button.

3.  Use the "SELECT keys" to select [中文简体], [繁體中文] or [ENGLISH].

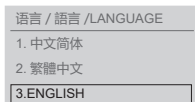

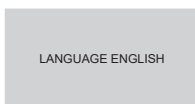

-  Press the "Enter" button.





(To return )

Anti freezing

Set whether or not to run the water for the bowl unit and top unit automatically at a fixed interval in order to prevent freezing

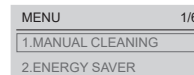

1.  Press the "Menu, Return" button.





2.  Use the "SELECT keys" to select [OTHER SETTING].

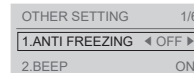

-  Press the "Enter" button.

3.  Use the "SELECT keys" to select [ANTI FREEZING].



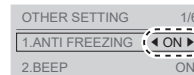

4.   Use the "SELECT keys" to select [ON] or [OFF].





<For setting to [ON]>

When the time is set, the bowl unit is cleaned in about 10 minutes intervals to prevent freezing.

-  Press the "Enter" button.

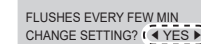
5.   Use the "SELECT keys" to select [YES].



-  Press the "Enter" button.

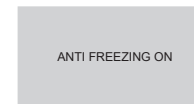

(To return )

Changing Settings

Beep sound

Set whether or not to make a beep sound

1. Press the "Menu, Return" button.

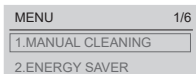

2. Use the "SELECT keys" to select [OTHER SETTING].



- Press the "Enter" button.

3. Use the "SELECT keys" to select [BEEP].

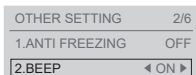

4. Use the "SELECT keys" to select [ON] or [OFF].

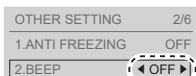

- Press the "Enter" button.



(To return)

Lower water level

Lower the bowl unit water level
(For reducing water rebound, collecting a stool sample, etc.)

1. Press the "Menu, Return" button.

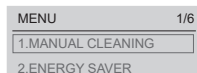

2. Use the "SELECT keys" to select [OTHER SETTING].



- Press the "Enter" button.

3. Use the "SELECT keys" to select [LOWER WATER LEVEL].

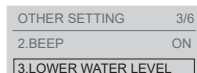

- Press the "Enter" button.

The water in the bowl unit flows and accumulates at a low water level.

Settings complete

(To return)

Note: The water level returns normal when the toilet is flushed. Please set this function each time you want to lower the water level.

Pressure / position setting

Set whether or not to keep your favorite pressure and position settings

1. Press the "Menu, Return" button.

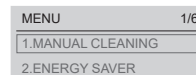

2. Use the "SELECT keys" to select [OTHER SETTING].



- Press the "Enter" button.

3. Use the "SELECT keys" to select [PRESSURE / POSITION SETTING].

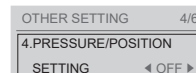

4. Use the "SELECT keys" to select [ON] or [OFF].

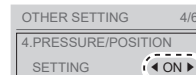

- Press the "Enter" button.

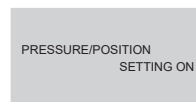

(To return)

Personal setting

Set whether or not to use the personal setting

1. Press the "Menu, Return" button.

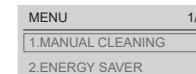

2. Use the "SELECT keys" to select [OTHER SETTING].



- Press the "Enter" button.

3. Use the "SELECT keys" to select [PERSONAL SETTING].

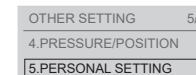

- Press the "Enter" button.

4. Use the "SELECT keys" to select [SETTING].

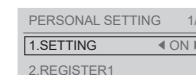

5. Use the "SELECT keys" to select [ON] or [OFF].

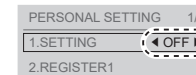

- Press the "Enter" button.

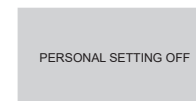

(To return)

Changing Settings

Registering Personal Settings

Register your preferred wand position, etc.

1. Press the "Menu, Return" button.

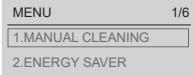

2. Use the "SELECT keys" to select [OTHER SETTING].



- Press the "Enter" button.

3. Use the "SELECT keys" to select [PERSONAL SETTING].

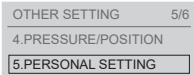

- Press the "Enter" button.

4. Use the SELECT keys to select the desired register number from [REGISTER1], [REGISTER2], [REGISTER3] or [REGISTER4].

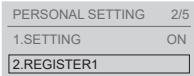

- Press the "Enter" button.

5. Use the "SELECT keys" to select [PRESSURE].

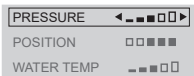

- Use the "SELECT keys" to select the "level".

6. Use the "SELECT keys" to select [POSITION].



- Use the "SELECT keys" to select the "level".

7. Use the "SELECT keys" to select [WATER TEMP].

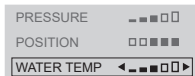

- Use the "SELECT keys" to select the "level".

8. Press the "Enter" button.

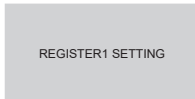

(To return)

Sensor detection range

You can change when to open the toilet lid upon entering the bathroom

1. Press the "Menu, Return" button.

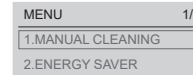

2. Use the "SELECT keys" to select [OTHER SETTING].



- Press the "Enter" button.

3. Use the "SELECT keys" to select [SENSOR DETECTION RANGE].

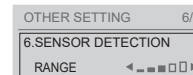

4. Use the "SELECT keys" to select [SET1], [SET2], [SET3], [SET4] or [SET5].

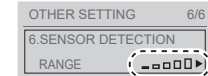

(Example) When to open the toilet lid upon entering the bathroom.



- Press the "Enter" button.



(To return)

Maintenance

Before Maintenance

⚠ WARNING

Always turn off the power before maintenance or inspection.

Failure to do so may cause electric shock or malfunction, resulting in a breakdown.

For safety, turn the power OFF before maintenance.*1*2

When the power is turned OFF, the Power LED is unilluminated.

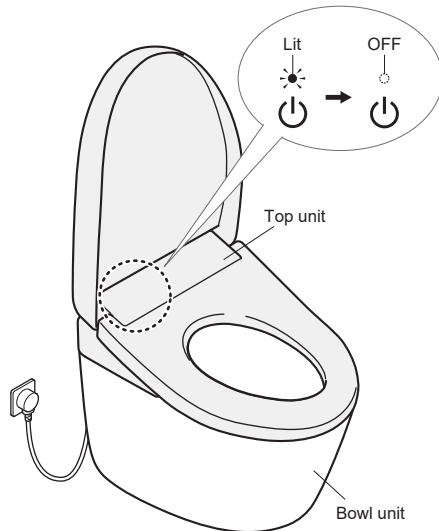

To turn the power "OFF"

Unplug the power plug.

To turn the power "ON"

Insert the power plug.

▶ The "Power" LED illuminates.

Power Plug



• Dry cloth



• Wet cloth

Approximately once a month

1. Unplug the power plug and wipe it with a dry cloth.



2. Insert the power plug.

▶ The "Power" LED illuminates.

⚠ WARNING

Periodically remove dust from the blades and other parts of the power plug.

Unplug the power plug and wipe it with a dry cloth.

Fully insert the power plug.

When unplugging the power plug, hold the main body of the power plug.

Pulling the power cord may damage the power plug or power cord.



Top unit and bowl unit maintenance

Limescale and other dirt may build up depending on water quality, cleaning frequency. Regular cleaning is recommended to prevent limescale and other dirt build-up.

Note: Due to the nature of the material, a powdery residue appears on the surface of the product.

However, this does not affect the product's quality.

If you are concerned about this, please clean it the same way as you clean the top unit.

Top Unit



• Soft cloth soaked in water



• Toilet paper
• Dry cloth
• Nylon scrubbing brush
• Cleaning sponge (melamine sponge, etc.)

May cause damage.

Approximately daily

1. Turn the power "OFF". (→Page 46)

2. Wipe with a soft cloth that has been soaked in water and wrung out thoroughly.

For heavy dirt

Wipe with a soft cloth soaked in diluted, pH neutral kitchen detergent, and then wipe with a soft cloth soaked in water.

Attention

Do not rub the surface of the unit too hard.

This can cause scratches on the surface.

It may also impair the texture.

For glossy products : Scratches can reduce the glossiness.

For matte color products : Damage to the matte surface causes unexpected glossiness.



• pH neutral kitchen detergent



• Paint thinner
• Benzene
• Powdered cleanser

3. Turn the power "ON". (→Page 46)

▶ The "Power" LED illuminates.

Attention

This product is an electric appliance. Be careful not to let water seep inside or leave detergent in the gap between the top unit and bowl unit.

Do not put any cleaning solution directly onto the warm air outlet or cover around the wand, etc. May damage plastic parts or cause a malfunction.

When using a toilet cleaner to clean the toilet, rinse it off within 3 minutes and leave the toilet seat and toilet lid open.

Wipe off any cleaner that remains on the bowl unit. If vapor from a toilet cleaner enters the top unit, it may cause a malfunction.

<If "Auto flush lid closed" (→Pages 30, 31) is turned ON> (→Page 10)

Do not press or pull the warm air outlet or cover around the wand with excessive force. Doing so may cause damage or failure.

Wipe the back surface of the toilet seat and the toilet seat cushions with a soft cloth tightly wrung out with water.

Otherwise adhesion of dirt may result in discoloration.

Be sure to wipe off any water droplets on the toilet seat. Otherwise, the seat sensor may malfunction.

*1 Except when using "Wand cleaning", "Bowl unit cleaning" and "Manual spray"

*2 The toilet lid does not open automatically for about 20 seconds after the power is turned ON (preparing).

Operate with the remote control.

Maintenance

Bowl Unit



- Cleaning sponge
- Brush
- Neutral toilet detergent



- Strongly acidic cleaners or strong alkaline cleaners
- Cleaners containing abrasive compounds
- Fluoride-based detergent (containing hydrogen fluoride or ammonium fluoride)
- Water-repelling cleaner
- Wire brush
- Abrasive nylon scrubbing brush

Approximately daily

1. Turn the power "OFF". (→Page 46)

2. Clean with a cleaning sponge or brush.

The water level in the bowl unit can be lowered to perform maintenance. Turn the power ON. (→Page 46)

<Bowl unit cleaning>

Remote control back side

How to remove the remote control (→Page 14)

- 1) Press the "Menu, Return" button.
- 2) Use the "SELECT keys" to select
 [MANUAL CLEANING].
 Press the "Enter" button.

- 3) Use the "SELECT keys" to select [BOWL CLEANING ON/OFF].

 Press the "Enter" button.
 - The water in the bowl unit flows, and then drains. After that, the water level drops for about 50 seconds. Clean inside the bowl unit.
↓
 - The water in the bowl unit drains, and then returns to its original level.
 - To stop part way through.
 - Press "Stop" button on the front side of the remote control.

If the bowl unit is clogged

Using plunger or similar, provide 4 in (10 cm) or more clearance between the top of the bowl unit and the water surface. Use commercially available tools that are made for unclogging the bowl unit.
(May cause overflow of dirty water and water damage.)

If the floor is dirty

Clean it with a well wrung cloth. Otherwise, stains or corrosion may occur on the floor.

Note: *Sitting is recommended to reduce splashing caused by standing and urinating.*

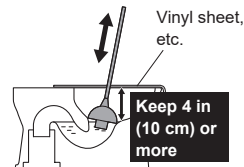

3. Turn the power "ON". (→Page 46)

- ▶ The "Power" LED illuminates.

Attention

Be careful not to expose the top unit or the gap between it and the bowl unit to water. Otherwise, water may overflow into the room.

Do not use any water repellent, stain-proofing cleaner or surface coating agent. These products would not damage the porcelain surface, but they may cover the porcelain surface and reduce the effect of the built-in stain prevention technology.

If you notice limescale build-up on the top unit and bowl unit

The following cleaning agents can be used.

Usable descaling agents



100% citric acid
(for consumption or cleaning)

Do not use descaling agents that contain organic acids other than citric acid, surfactants, silicone, or preservatives.

Request regarding the descaling agent

Please use the descaling agent properly according to the precautions from the manufacturer. Use the descaling agent with the correct dilution. Do not use undiluted liquid or powder directly on the product, and make sure the agent is completely dissolved. Do not use a descaling agent other than the specified descaling agents. Doing so may cause damage or discoloration.

How to dilute

- 1) Pour 6.8 fl oz (200 ml) of water in a cup or similar object.
- 2) Add 1 teaspoon (0.2 lb (5 g)) of citric acid and stir well.



Stir the descaling agent well to ensure that there is no undissolved citric acid or sediment.

- 3) Transfer the water with dissolved citric acid to a spray bottle or similar object to use.

1. Turn the power "OFF". (→Page 46)

2. Transfer the water with dissolved citric acid to a spray bottle, then spray it on toilet paper.

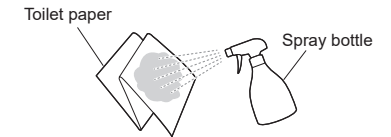

Attention

Do not spray cleaning agent directly on the top unit. Doing so may cause discoloration or damage.

3. Use the toilet paper from step 2 to any areas where you notice limescale build-up.

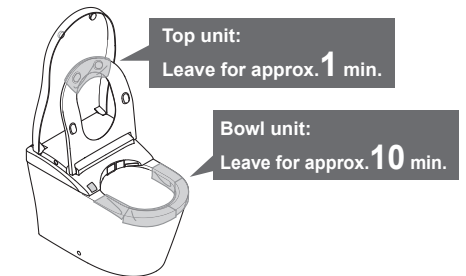

4. Remove the toilet paper and clean. Wipe the surface of the top unit and bowl unit with a soft cloth that has been soaked in water and wrung out thoroughly. Clean the inside of the bowl unit with a cleaning sponge or brush.
 - ▶ Wipe off or rinse thoroughly to ensure no cleaning agent remains.

Attention

If any cleaning agent is spilled on the product, please wipe it off with a soft cloth that has been soaked in water and wrung out thoroughly.

Failure to do so may cause discoloration.

5. Turn the power "ON". (→Page 46)

- ▶ The "Power" LED illuminates.

Maintenance

Manual Spray







EWATER+ mist can be sprayed to separate dirt from the surface for maintenance.

Approximately daily

<Manual spray>

Remote control back side

How to remove the remote control (→Page 14)

- 1)  Press the "Menu, Return" button.
- 2)  Use the "SELECT keys" to select [MANUAL CLEANING].

-  Press the "Enter" button.
- 3)  Use the "SELECT keys" to select [MANUAL SPRAY].

-  Press the "Enter" button.

► EWATER+ mist is sprayed on the bowl unit and underneath the front of the toilet seat.
Wipe off the back of the toilet seat with a soft cloth every time mist is sprayed.
Then, perform maintenance on the bowl unit. (→Page 48)

Note: It cannot be used when the wand is out or when you are sitting on the toilet seat.

Note: To perform maintenance with a brush, etc. (→Page 48 "Bowl unit cleaning")

Deodorizing Filter

Approximately once a month

1. Turn the power "OFF". (→Page 46)
2. Hold the tab of the deodorizing filter and pull it out toward you.

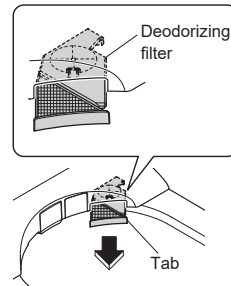

Attention

Do not pull the unit with undue force.
Doing so may cause damage or malfunction.
The deodorizing filter cannot be removed completely.

3. Clean with a tool such as a toothbrush.

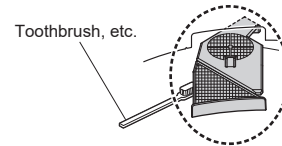

4. Push in the deodorizing filter.

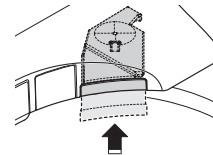

Push firmly until it is in the original position.

5. Turn the power "ON". (→Page 46)

► The "Power" LED illuminates.

Gap between the Top Unit and Bowl Unit

You can lift up the top unit with the cleaning lift button and clean the gap between it and the bowl unit.



• Soft cloth soaked in water



• Toilet paper

• Dry cloth

• Nylon scrubbing brush

• Cleaning sponge (melamine sponge, etc.)

May cause damage.

Approximately once a month

1. Turn the power "OFF". (→Page 46)
2. Open the toilet seat and lid.
3. Press the cleaning lift button.

► This raises the front side of the top unit.

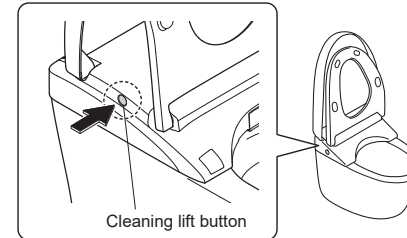

4. Clean the gap.

► Wipe with a soft cloth soaked in a diluted, neutral kitchen detergent. Then, wipe it with a soft cloth soaked in water so that no detergent remains.

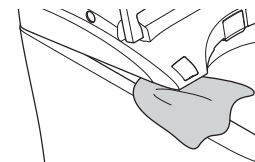

CAUTION

Do not use the product while the top unit is lifted up by the cleaning lift.
When lowering the top unit by the cleaning lift, do not insert your fingers into the gap between the top unit and the bowl unit.

Attention

Do not directly spray cleaner and water.
Do not force the toilet seat or lid to move while the top unit is raised up.

5. Close the toilet seat.

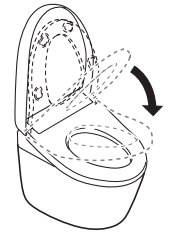

6. Push the top unit down firmly until a click sound is no longer heard.

Make sure to push these locations

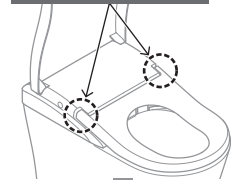

Push it straight down

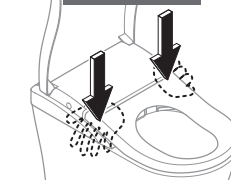

*Up to 6 clicks can be heard.

7. Turn the power "ON". (→Page 46)

► The "Power" LED illuminates.

Maintenance

Gap between the Top Unit and the Toilet Lid

The toilet lid can be removed for thorough cleaning.



- Soft cloth soaked in water

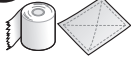

- Toilet paper
 - Dry cloth
 - Nylon scrubbing brush
 - Cleaning sponge (melamine sponge, etc.)
- May cause damage.

Approximately once a month

1. Turn the power "OFF". (→Page 46)

2. Remove the toilet lid.

Slightly tilt the toilet lid to the front.

- A Pull right side outward.
- B Disconnect the hinge from the tab and pull up.
- C Remove the toilet lid.

Hold with both hands

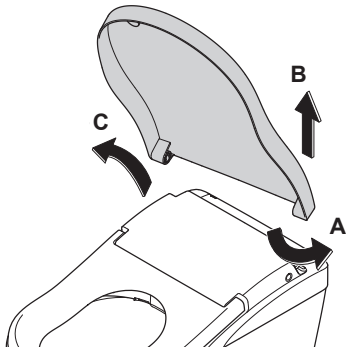

3. Wipe with a soft cloth that has been soaked in water and wrung-out thoroughly.

4. Reinstall the toilet lid.

- D Align the left side pin and hinge parts. Slightly tilt the toilet lid to the front.
- E While pulling right side outward.
- F Mount by joining the hinge with the tab.

Attention

Be careful not to pinch your fingers.

Hold with both hands

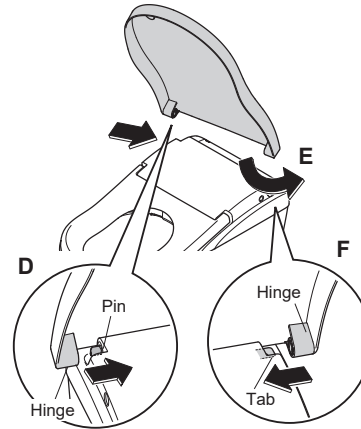

5. Turn the power "ON". (→Page 46)

▶ The "Power" LED illuminates.

6. Open and close the toilet lid to check the reinstallation.

Wand



- Soft cloth

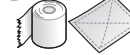

- Toilet paper
 - Dry cloth
 - Nylon scrubbing brush
 - Cleaning sponge (melamine sponge, etc.)
- May cause damage.

Approximately once a month If you notice dirt (Wand cleaning)

1. Extend the wand.

To operate from the back of remote control

Remote control back side

How to remove the remote control (→Page 14)

- 1) Press the "Menu, Return" button.
- 2) Use the "SELECT keys" to select [MANUAL CLEANING].
 Press the "Enter" button.
- 3) Use the "SELECT keys" to select [WAND CLEANING ON/OFF].
 Press the "Enter" button.

To operate from the front of remote control

Recommended if the remote control is secured to prevent theft, etc.

- 1) Press "Stop" button for about 10 seconds or longer.
- 2) Press "Front washing" button for about 3 seconds or longer.

- ▶ The wand extends and water sprays out for cleaning.
- ▶ The wand automatically retracts after about 5 minutes.

2. Wipe with a soft, wet cloth.

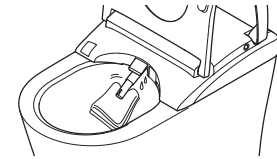

Attention

Do not pull, push or press the wand with excessive force.

May cause damage or malfunction.

- 3.

Press "Stop" button on the front side of the remote control.

▶ The wand retracts.

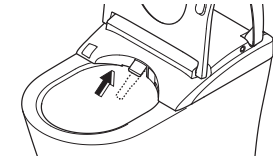

Maintenance

Drain Plug With Water Supply Filter

Approximately once every 6 months
If you think the water pressure has weakened

1. Remove the shutoff valve cover, and then close the shutoff valve.

▶ The water supply stops.

CAUTION

Do not remove the drain plug with water supply filter while the shutoff valve is open.
Otherwise, water may leak out.

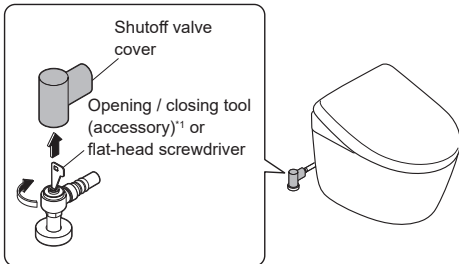

2. Press "Wand CLEAN" button.
 - Release the pressure from the water supply pipe.

3. Turn the power "OFF". (→Page 46)

4. Open the toilet seat and lid.

5. Open the cover and remove the drain plug with water supply filter.

- 1) Insert a flat-head screwdriver in the hook of the cover to open it.

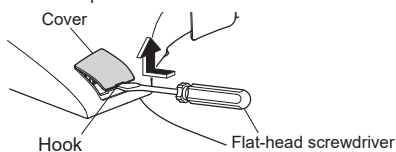

- 2) Loosen the drain plug with water supply filter with a flat-head screwdriver and then pull it.

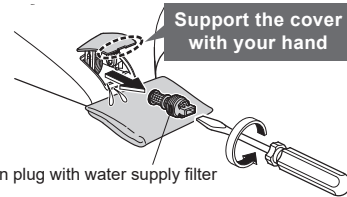

6. Clean the filter with a tool such as a toothbrush.

▶ Also, remove any dust from inside the hole of the drain plug with water supply filter.

7. Reinstall the drain plug with water supply filter and close the cover.

- 1) Insert the drain plug with water supply filter and use a flat-head screwdriver to tighten it securely.

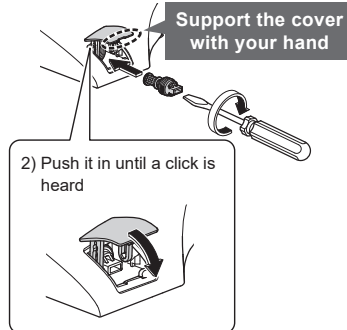

8. Turn the power "ON". (→Page 46)

▶ The "Power" LED illuminates.

9. Open the shutoff valve, and then install the shutoff valve cover.

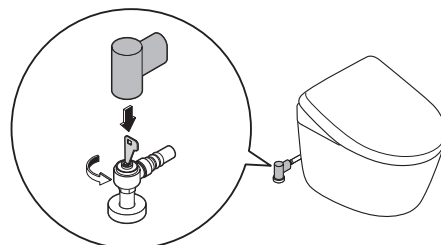

Water Supply Filter (Bowl Unit)

Approximately once every 6 months

1. Remove the shutoff valve cover, and then close the shutoff valve.

▶ The water supply stops.

CAUTION

Do not remove the water supply filter while the shutoff valve is open.
Otherwise, water may leak out.

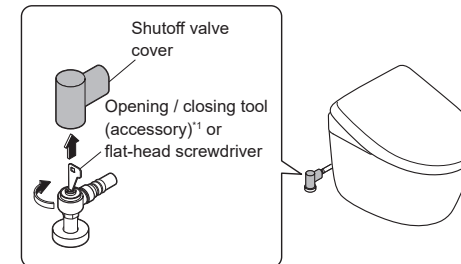

Always perform this step

2. Press the "Wand CLEAN" button.
 - Release the pressure from the water supply pipe. (Otherwise, water may leak out.)

3. Turn the power "OFF". (→Page 46)

4. Loosen the cap of the water supply filter to remove the water supply filter.

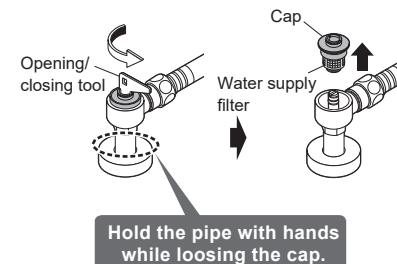

5. Remove the water supply filter from the cap and clean it with a toothbrush or similar instrument.

Attention

Do not use detergent.
Do not apply excessive force to the water supply filter.
Otherwise, deformation may occur.



6. Attach the water supply filter to the cap.



7. Install the cap of the water supply filter to the original position and tighten it with the opening/closing tool.

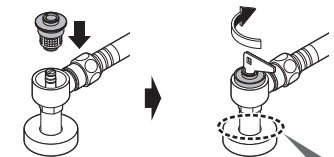

8. Open the shutoff valve, and then install the shutoff valve cover.

▶ Check that there are no leaks in the shutoff valve or plumbing connections.

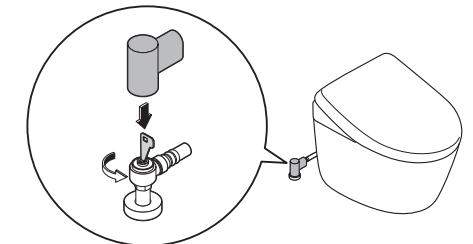

9. Turn the power "ON". (→Page 46)

▶ The "Power" LED illuminates.

*1 Use the supplied opening/closing tool.

What to Do?

If the water does not flow due to a power outage (when water failure hasn't occurred)

The bowl unit can be flushed with the manual water supply cord (orange) and manual water storage cord (white).

Watch video

If the water does not flow due to a power outage

<https://youtube.com/playlist?list=PL8IJONSGBXLCS5fHWTMZ13wVNHnjLbYvU>



*May incur communication charges.

*You may not be able to watch the video depending on your environment.

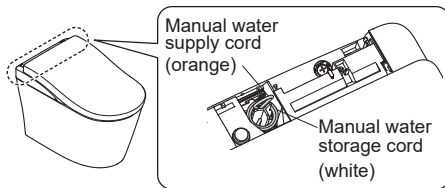

1. Remove the rear cover.

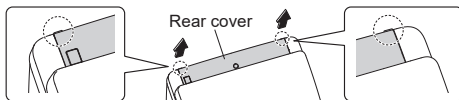

Lift up at the location shown in the illustration and remove it.

2. Open the toilet seat and lid.

3. Operate the manual water supply cord (orange) to supply water to the bowl unit.

- 1) Pull the manual water supply cord (orange) to its stop position.



Manual water supply cord (orange)

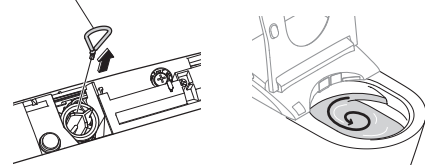

- 2) Release the manual water supply cord (orange).

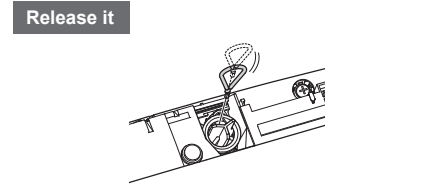

4. Operate the manual water storage cord (white) to raise the water level in the bowl unit and drain the water in the bowl unit.

- 1) Pull the manual water storage cord (white) to its stop position and hold it.

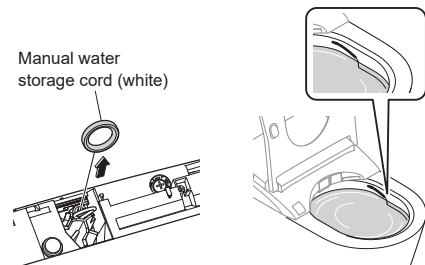

- 2) Release the manual water storage cord (white).

Release it
(The water in the bowl unit drains and the water level drops.)

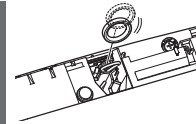

Note: Continuously pulling the manual water storage cord (white) may flood the bowl unit.

Attention

If the water in the bowl unit does not drain after releasing the manual water storage cord (white), the bowl unit may be clogged.

Pull the manual water supply cord (orange) to its stop position, release it, and fix the bowl unit. (→Page 48)
Water may overflow.

5. Place the manual water storage cord (white) back in the original position.

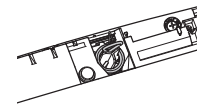

Always perform this step

6. When the water level in the bowl unit drops to the original level, operate the manual water supply cord (orange) to stop supplying water to the bowl unit.

Attention

If the waste material does not flush down completely, repeat the procedure from step 3.

- 1) Pull the manual water supply cord (orange) to its stop position.

Pull it

Manual water supply cord (orange)

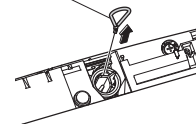

- 2) Release the manual water supply cord (orange).

Release it

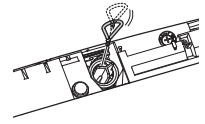

Check that water has stopped being supplied to the bowl unit.

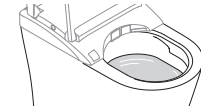

Attention

The manual water supply cord (orange) is pulled to its stop position to change whether to supply water to the bowl unit or stop it.

Be sure to pull the manual water supply cord (orange) to its stop position to stop supplying water to the bowl unit.

7. Install the rear cover.

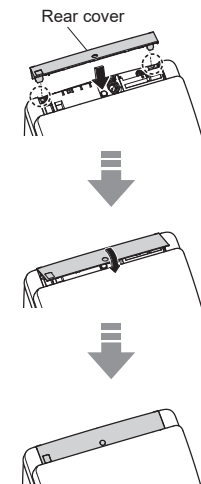

Attention

When power is restored, be sure to perform a "Flush". To prevent waste from remaining in the discharge pipe.

You can also flush the bowl unit with a bucket. (→Page 58)

What to Do?

If the water does not flow due to a water service interruption

1. Use a bucket to flush the bowl unit. (About 6–8 L)

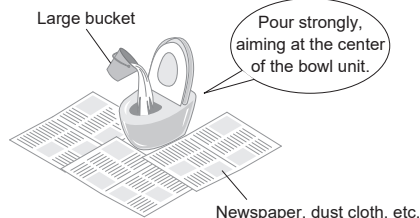

2. If the water level is low after flushing, add more water. (Until the water level does not rise further.)
 - ▶ Prevents odors.

Attention

Before starting work, turn "Auto flushing" OFF. (→Page 30)

When the water supply is restored, make sure to first use water in the bath or kitchen (not with this product) to remove air from the water supply pipes.

Otherwise, air or foreign objects may enter this product, causing failure.

After that, be sure to perform a full flush.

To prevent waste from remaining in the drain pipe.

If you cannot operate with the remote control

Flush is also possible using the buttons on the right side of top unit.

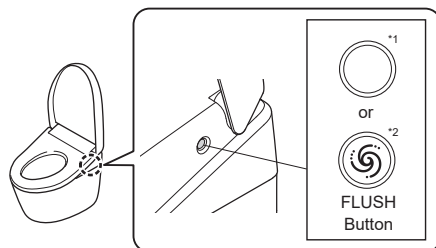

If the low battery warning LED is flashing, replace the batteries.

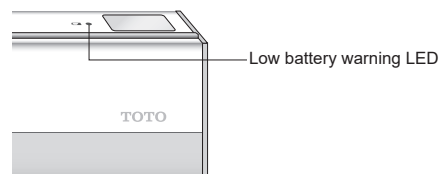

Replacing the batteries

1. Turn the power "OFF". (→Page 46)
2. Remove the remote control from the hanger. (→Page 14)
3. Open the battery cover and replace two AA batteries. (→Page 14)
 - ▶ The low battery warning LED goes off.

4. Mount the remote control in the hanger. (→Page 14)

5. Turn the power "ON". (→Page 46)

▶ The "Power" LED illuminates.

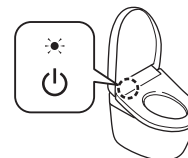

Attention

"ON" and "OFF" settings of the functions such as the energy saver function may be canceled when the batteries are replaced. Set them again.

Freeze Damage Prevention

When the ambient temperature is likely to drop to 32 °F (0 °C) or lower, take measures to prevent freezing.

Attention

When the ambient temperature is likely to drop to 32°F (0 °C) or lower, do not use the energy saver feature. Otherwise, the product may break down.

Warm the bathroom or take measures against freezing so that the ambient temperature does not drop below 32 °F (0° C).

Before starting to work, set "Auto flushing" (Page 30) and "Auto open / close" (Page 32) to "OFF".

How to Freeze Damage Prevention (Dynamic mode)

This function runs the water for the bowl unit and top unit automatically at a fixed interval in order to prevent freezing.

How to Set

1. Turn "Anti freezing" ON with the remote control. (→Page 41)
 - ▶ The "Power" LED flashes.
 - The toilet flushes at intervals of about 10 minutes.
 - About 1.69 oz (about 50 ml) of water comes out from near the wand at intervals of about 5 minutes. (The wand remains retracted.)

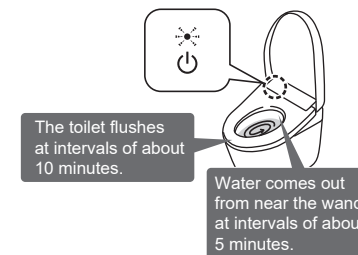

*1 For non-matte-colored products

*2 For matte-colored products

What to Do?

Long Periods of Disuse

If the toilet is in a location you will not visit for a long time, drain the water.

The water in the tank may cause malfunctions or become contaminated and cause skin irritation or other problems.

The water may freeze, causing damage to the product.

Attention

When there is a risk of freezing, take measures to prevent freezing. (→Page 59)

Otherwise, the product may break down.

Note: Do not drain water when the top unit is lifted up with the "Cleaning lift". (→Page 51)

How to drain the water

1. Remove the shutoff valve cover, and then close the shutoff valve.
 - ▶ The water supply stops.

CAUTION

Do not remove the drain plug with water supply filter while the shutoff valve is open.

Otherwise, water may leak out.

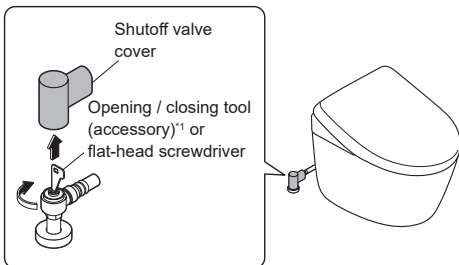

2. Install the shutoff valve cover.



Press "Full flush" button on the remote control to drain the tank.²



4. Press "Wand CLEAN" button.
 - Release the pressure from the water supply pipe.

5. Turn the power "OFF". (→Page 46)

6. Drain the pipe.
 - 1) Open the toilet seat and lid.
 - 2) Insert a flat-head screwdriver in the hook of the cover to open it.

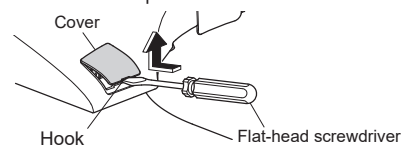

- 3) Loosen the drain plug with water supply filter with a flat-head screwdriver and then pull it.

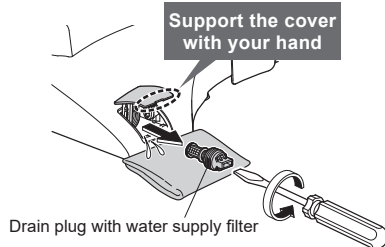

7. Reinstall the drain plug with water supply filter and close the cover.
 - 1) Insert the drain plug with water supply filter and use a flat-head screwdriver to tighten it securely.

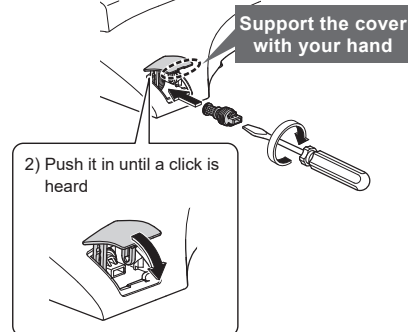

If water may get frozen

- ▶ Add antifreeze solution to the water in the bowl to prevent freezing. (The antifreeze solution should not be flushed out. Collect it before using the toilet and dispose of it.)

To use the product again

- ▶ The water needs to be resupplied. (→See below.)

Resupplying the Water

1. Remove the shutoff valve cover, and then open the shutoff valve.
 - ▶ Check that water is not leaking from a pipe or the top unit.

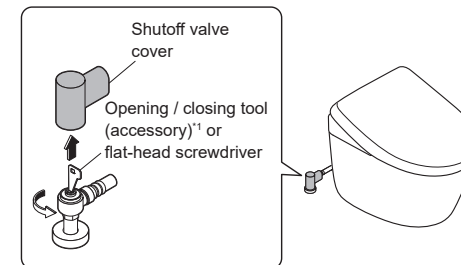

2. Install the shutoff valve cover.

3. If the power is not on, turn the power ON. (→Page 46)

- ▶ The "Power" LED illuminates.

4. Discharge water from the wand.
 - 1) Keep your hand or arm in contact with the seat sensor (for details, →refer to Page 9)
 - 2) Press "Rear washing" button to discharge water from the wand.
 - ▶ Catch the water in a paper cup or other receptacle.

- 3) Move your hand or arm from the seat sensor

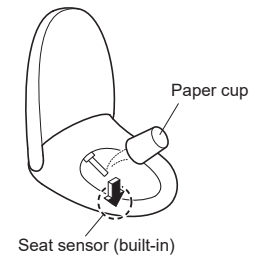

5. Press "Full flush" button.²

Attention

The bowl unit cannot be flushed when there is not enough water in the tank. In this case, do not perform any operations.

- ▶ The LEDs on the main display flashes while water is being supplied to the tank, and then changes to lit when water supply is complete. It takes about 80 seconds for water supply to complete. (The required time depends on the usage conditions such as the water supply pressure.)

If the remaining water has frozen and no water comes out

- ▶ Heat the inside of the bathroom, and warm the water supply hose and shutoff valve using a cloth soaked in warm water.



After the bowl unit fills with water, press "Full flush" button again.²

*1 Use the supplied opening/closing tool.

*2 If "Auto flush lid closed" is turned ON, the toilet lid closes before flushing the bowl unit.

What to Do?

How to remove the operation guide

To remove, follow the procedure below.

1. Turn the power "OFF". (→Page 46)
2. Remove the remote control from the hanger. (→Page 14)
3. Remove the hanger and operation guide.

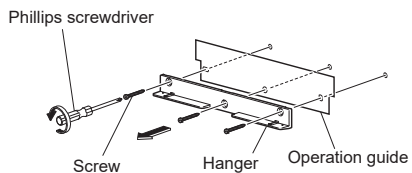

4. Screw the hanger on the wall.



5. Mount the remote control in the hanger. (→Page 14)

6. Turn the power "ON". (→Page 46)
 - ▶ The "Power" LED illuminates.

To install back the operation guide, follow the procedure above.

- ▶ Install the operation guide at step 4.

Troubleshooting

First, try the actions described on pages 63–74. If the problem persists, consult the installer, seller, or TOTO Service (→see contact information on the back cover).

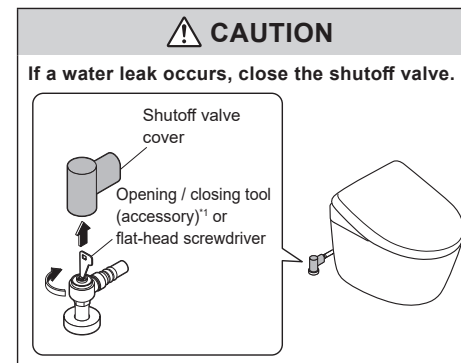

In the following case, unplug the power plug and consult with TOTO customer service (→see contact information on the back cover).

"Power" LED, "Seat" LED, and "Energy saver" LED are flickering

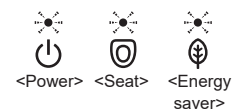

"Seat" LED is flickering



The beep sound keeps sounding

Please check first (A–C)

A: Is the Power LED illuminated?
Is the top unit working?

Is the "Power" LED on the main display flashing?

- ▶ The "Anti freezing" is set to "ON". (→Pages 41, 59)

Is the breaker on the distribution board turned on?

- ▶ Check whether there is a power outage or the breaker has turned "OFF".

Is the "Power ON/OFF" setting "OFF"?

- ▶ Switch it to "ON" with the remote control. (→Page 15 2-2.2)

B: Is the Energy saver LED lit?

- ▶ The energy saver (→Page 28) is in operation while the LED is lit, so the toilet seat heater may be turned off.

C: Is the remote control working?

Is the low battery warning LED on the top surface of the remote control flashing?

- ▶ Replace the batteries. (→Pages 14, 58)

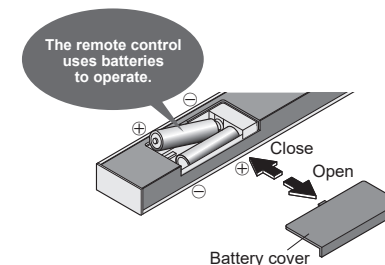

Is the remote control transmitter or the remote control receiver blocked?

- ▶ Remove obstructions, dirt, water droplets or any other blockages.

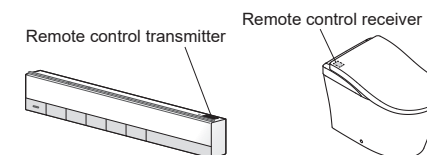

*1 Use the supplied opening/closing tool.

Troubleshooting

Rear Washing, Front Washing and Wand

Trouble	Please check
The wand (or washing water) does not come out	<p>When the temperature is low, it takes time for the wand to come out after the remote control button is pressed because the water must be warmed up first.</p> <p>Has the toilet been sat "ON" and used continuously for 2 hours or longer? (If so, operation is stopped for safety purposes.) ▶ Stand up from the seat and then use again.</p> <p>When sitting on the toilet seat, is there a toilet seat cover or clothing on the seat sensor? Or are you sitting without touching the seat sensor? ▶ Check the location of the seat sensor and sit down so that it touches your skin directly. (→Page 9)</p> <p>Are you using a toilet seat cover, a toilet lid cover or a seat for infants? ▶ Remove any covers. When using a seat for infants or a soft highchair, remove after each use. (→Page 10)</p>  <p>✎ Are you pressing "Wand CLEAN" button? ✎ When you press "Wand CLEAN" button, "EWATER+" comes out from the vicinity of the wand to clean the wand. ▶ To clean the wand with it extended, perform "Wand cleaning". (→Page 53)</p> <p>If the water supply pressure drops significantly, for example if water is used elsewhere or if there is a water failure, the function may stop for safety. ▶ Turn the power OFF and wait about 10 seconds before turning the power ON again. (→Page 46)</p> <p>If the above symptom reappears There may be a malfunction. ▶ Consult with TOTO customer service (→see contact information on the back cover).</p>
The wand extends but the washing water does not come out / The washing water pressure is weak	<p>Has a water failure occurred? ▶ ■ Press "Stop" button on the remote control and wait until water service is restored.</p> <p>Is the shutoff valve closed? ▶ Fully open the shutoff valve. (→Page 15)</p> <p>Is the drain plug with water supply filter clogged with foreign matter? ▶ Clean the filter. (→Page 54)</p> <p>Is the water pressure set to a low level? (→Page 19)</p>
The washing water is cold	<p>Is the warm water temperature set to "OFF" or a low level? (→Page 24)</p> <p>When the temperature of the water supply or the bathroom is low, the water temperature may be low when first sprayed.</p>
Stops in the middle of use	<p>"Rear washing", "Rear soft washing", "Front washing", and "Wide front washing" stop automatically after about 5 minutes of continuous use.</p> <p>Does the seat sensor have difficulty detecting? ▶ If you get up slightly from the seat or sit leftward on the seat, the seat sensor may temporarily stop detecting your presence, causing washing to stop prematurely. (→Page 9)</p>

Water comes out unexpectedly from the wand

Is the "Power" LED (green) on the main display flashing? (→Pages 41, 59)
▶ The "Anti freezing (dynamic mode)" is set to "ON". (Water comes out from near the wand at about 5 minutes intervals and the bowl unit flushes at about 10 minutes intervals.)

When you sit on the toilet seat, water comes out for several seconds while water is warmed up.

Has the CLEAN indicator lit up in a cycle?
▶ "Auto wand CLEAN" starts and the wand is cleaned. (→Page 18)

Warm air drying

Trouble	Please check
The dryer temperature is low	Is the dryer temperature set to low level? (→Page 25)
Stops in the middle of use	<p>The feature stops automatically after about 10 minutes of continuous use.</p> <p>Does the seat sensor have difficulty detecting? ▶ If you get up slightly from the seat or sit leftward on the seat, the seat sensor may temporarily stop detecting your presence, causing washing to stop prematurely. (→Page 9)</p>

Flushing

Trouble	Please check
For not flushing	<p>Is the shutoff valve fully open? (→Page 15)</p> <p>Has a power outage occurred? ▶ You can use the manual water supply cord (orange) and manual water storage cord (white) to flush the bowl unit. (→Pages 56, 57)</p> <p>Has a water failure occurred? ▶ Use a bucket to flush water. (→Page 58)</p>
The toilet does not flush even when the button of remote control is pressed	<p>Is the LEDs on the main display flashing? ▶ The tank is filling with water. It takes about a minute for water supply to complete. (The required time depends on the usage conditions such as the water supply pressure.)</p>
The bowl unit does not clean automatically or timing is delayed (Auto flushing)	<p>Is "Auto flushing" set to "OFF"? ▶ Set to "ON". (→Page 30)</p> <p>Even if "Auto flushing" is set to "ON", it is not available in the following instances.</p> <p>For about 60 seconds after the bowl unit flushes. ▶ After about 60 seconds have passed, use the remote control to flush the bowl unit. (→Page 20)</p> <p>When the time spent sitting on the toilet seat is less than about 6 seconds. ▶ Use the remote control to flush the bowl unit. (→Page 20)</p> <p>When the toilet is used in standing position. ▶ The water flows after a maximum of about 20 seconds from when you leave the bathroom. ▶ If "Auto flush lid closed" is turned ON, 30 seconds after leaving the bathroom, the toilet seat and lid close and then the bowl unit flushes.</p>

Troubleshooting

Flushing (continue)

Trouble	Please check
The bowl unit does not clean automatically or timing is delayed (Auto flushing)	<p>When sitting on the toilet seat, is there a toilet seat cover or clothing on the seat sensor? Or are you sitting without touching the seat sensor? ▶ Check the location of the seat sensor and sit down so that it touches your skin directly. (→Page 9)</p> <p>The timing for the "Auto flushing" can be changed. (→Page 32)</p>
The toilet flushes on its own	<p>Is "Auto flushing" set to "ON"? ▶ You can turn it "OFF". (→Page 30)</p> <p>Does the seat sensor have difficulty detecting? ▶ If you get up slightly from the seat or sit leftward on the seat, the seat sensor may not detect properly, causing the bowl unit to be flushed during use. (→Page 9)</p> <p>A light flush may be performed under the following conditions due to the bathroom layout, etc.</p> <ul style="list-style-type: none"> • The toilet seat and lid are open and you stand in front of or walk past the front of the bowl unit. • "Auto open / close" is set to [SEAT/LID]. (→Page 34) <p>Is the "Power" LED (green) on the main display flashing? ▶ The "Anti freezing (dynamic mode)" is set to "ON". (Water comes out from near the wand at about 5 minutes intervals and the bowl unit flushes at about 10 minutes intervals.) (→Pages 41, 59)</p>
Waste material does not flush down completely	<p>Is the shutoff valve fully open? (→Page 15)</p> <p>Is the water supply filter clogged? ▶ Clean the filter. (→Page 55)</p> <p>Is the water supply to the toilet disrupted by other running water fixtures? ▶ Cease using other fixtures and then flush the toilet.</p> <p>Are the flush and light flush buttons being used correctly? (→Page 20) ▶ Full flush (for solid waste) : up to 33 ft (10 m) of toilet paper (single). ▶ Light flush (for liquid waste): up to 10 ft (3 m) of toilet paper (single).</p> <p>Flushing may be difficult depending the consistency of the waste material. ▶ Flush the toilet again. If the bowl unit is not cleansed with a flushing, remove the stains with a brush or similar instrument. (→Page 48)</p> <p>When the tank is filling, you cannot flush the toilet. ▶ Once the "Power" LED on the main display are lit and the tank fills up with water, flush the toilet.</p>
A small amount of water flows into the bowl unit after the unit flushes	<p>If the water supply pressure drops significantly, for example if water is used elsewhere or if there is a water failure, water is supplied so that the water surface in the bowl unit rises to a certain level.</p> <p>If the above symptom reappears ▶ There may be a malfunction. Consult with TOTO customer service (→see contact information on the back cover).</p>

Water keeps being supplied to the bowl unit	<p>Did you stop the water supply for flushing in case of power outage? ▶ Pull the manual water supply cord (orange) to stop supplying water. (→Page 57)</p>
Some barium remains after flushing	<p>It may be difficult to flush down substances with a higher specific gravity than water, such as barium. ▶ Flush the toilet again. If the bowl unit is not cleansed by flushing, clean it with a cleaning sponge or brush. (→Page 48)</p>
There is residue on the bowl unit surface	<p>Oil and other hard-to-see grime may stick to the bowl unit surface. ▶ Clean with (non-abrasive) neutral toilet detergent. (→Page 48)</p>
The bowl unit does not flush with the manual water supply cord (orange) and manual water storage cord (white)	<p>Did you pull the manual water supply cord (orange)? ▶ Pull the manual water supply cord (orange) to start to supply water. (→Page 56)</p> <p>The water level may not be sufficient. ▶ Continuously pull the manual water storage cord (white) until the water level in the bowl unit reaches the top of the water outlet. (→Pages 56, 57)</p>

Toilet Seat and Toilet Lid (Auto open / close)

Trouble	Please check
The toilet lid does not open automatically	<p>Is "Auto open / close" set to "OFF"? ▶ Set to "ON". (→Page 32)</p> <p>Even when set to "ON", "Auto open / close" is not performed for about 15 seconds after the toilet seat or toilet lid is closed.</p> <p>When the toilet lid is closed with the remote control or by hand To make the product more user-friendly, a time interval is set from when the lid is closed to when it will open next. ▶ Move away from the toilet and wait at least about 15 seconds before approaching the bowl unit again or open and close by hand. (→Page 20)</p> <p>Is "Auto open delay" set to [SET 2] or [SET 3]? (→Page 34)</p> <p>The toilet lid does not open automatically for about 20 seconds after the power is turned ON. ▶ Use the remote control to open or close it. (→Page 20)</p> <p>Is a toilet lid or seat cover installed? ▶ Remove any covers. (→Page 10)</p> <p>If a function such as "Auto flushing" is operating, the body sensor may not detect properly.</p> <p>You can change the detection range of the body sensor. (→Page 45)</p>
The toilet lid does not close automatically	<p>Is "Auto open / close" set to "OFF"? ▶ Set to "ON". (→Page 32)</p> <p>In the following cases, the toilet lid closes in about 5 minutes.</p> <ul style="list-style-type: none"> • When you did not sit on the toilet seat • When you sat on the toilet seat for less than 6 seconds

Troubleshooting

Toilet Seat and Toilet Lid (Auto open / close) (continue)

Trouble	Please check
The toilet lid opens on its own	<p>Because the body sensor can detect movement through the wall or door in front of the toilet, the "Auto open / close" function may cause the toilet lid to open automatically even when you are outside of the bathroom.</p> <ul style="list-style-type: none"> ▶ You can also set "Auto open / close" to "OFF". (→Page 32) ▶ You can change the detection range of the body sensor. (→Page 45) <p>Is a urinal or wash basin also installed in the bathroom?</p> <ul style="list-style-type: none"> ▶ The body sensor may detect someone using the urinal, causing the toilet lid to open or close. <p>The toilet lid opens before spraying EWATER+ mist for "Auto underseat CLEAN" or "Auto bowl CLEAN" and closes after completion.</p> <ul style="list-style-type: none"> ▶ You can select not to open the toilet lid when spraying mist. However, it may be less effective than when spraying mist after opening the toilet lid. <p>How to configure the setting Press the "Opening and closing the toilet lid" button and "Water pressure adjustment -" button at the same time for 10 seconds or longer.</p> <p>The setting changes each time they are pressed and held for 10 seconds or longer.</p> <ul style="list-style-type: none"> • Spraying mist after opening the toilet lid: Short beep ↓ ↑ • Spraying mist without opening the toilet lid: Long beep <Setting complete>
The toilet lid closes on its own	<p>Is "Auto open / close" set to "ON"?</p> <ul style="list-style-type: none"> ▶ You can turn it "OFF". (→Page 32) <p>Is "Auto close delay" set to [SET 1]? (→Page 33)</p> <p>When sitting on the toilet seat, is there a toilet seat cover or clothing on the seat sensor?</p> <p>Or are you sitting without touching the seat sensor?</p> <ul style="list-style-type: none"> ▶ Check the location of the seat sensor and sit down so that it touches your skin directly. (→Page 9)
The toilet lid and toilet seat open at the same time	<p>Is "Seat/lid" set to "Seat-lid"? (→Page 34)</p>
Stops (or closes) while opening	<p>If the toilet lid or seat hits an obstruction the first time it opens after the power is turned ON, it may stop (or close) partway during the next operation.</p> <ul style="list-style-type: none"> ▶ Eliminate any obstructions and turn the power OFF. Turn the power ON again after about 5 seconds. Then press the "Opening and closing the toilet lid" button on the remote control. (→Page 20)
The toilet lid does not close	<p>When the toilet lid closes may differ according to which functions are used.</p>
Cannot open or close with the remote control	<p>If it opens automatically.</p> <ul style="list-style-type: none"> ▶ Check "Is the remote control working?" (→Page 63) <p>If automatic opening does not work either</p> <ul style="list-style-type: none"> • The toilet lid may not be mounted correctly. ▶ Mount them correctly. (→Page 52) <p>Incorrect detection may occur when operating under fluorescent lights.</p>

Toilet Seat and Toilet Lid

Trouble	Please check
The toilet seat is cold	<p>Is the "Seat" LED flickering?</p> <ul style="list-style-type: none"> ▶ Consult with TOTO customer service. (→See contact information on the back cover) <p>Is the toilet seat temperature set to "OFF" or a low level? (→Page 25)</p> <p>If the time spent sitting on the toilet seat is short, the seat may not warm up. (→Page 16)</p> <p>Is energy saver in operation?</p> <p>The energy saver feature is enabled when the "Energy saver" LED is lit on the main display. When the energy saver feature is on, the toilet seat heater is OFF. (→Page 28)</p> <p>When you approach the seat or sit on the seat, the toilet seat heater is turned on temporarily and the seat is warmed to the setting temperature in about 60 seconds.</p> <ul style="list-style-type: none"> ▶ You can turn it "OFF" if the energy saver feature is "ON". (→Page 29) <p>Have you been seated for a long time?</p> <p>After about 20 minutes of sitting, the temperature starts going down, and after about 1 hour, the toilet seat heater is turned "OFF".</p> <ul style="list-style-type: none"> ▶ Stand up from the seat and then use again. <p>Is a toilet lid or seat cover installed?</p> <ul style="list-style-type: none"> ▶ Remove any covers. (→Page 10)
The toilet seat is hot	<p>If you hear a beep sound, unplug the power plug and consult with TOTO customer service (→See contact information on the back cover).</p>
The toilet seat and lid close on their own and then the bowl unit flushes	<p>Is "Auto flush lid closed" turned ON? (→Pages 30, 31)</p>

Troubleshooting

Auto flush lid closed

Trouble	Please check
"Auto flush lid closed" does not work	<p>Is "Auto flush lid closed" turned OFF? ▶ Turn it ON. (→Pages 30, 31)</p> <p>If "Auto flush lid closed" is turned ON: Check the "Auto flushing" and "Auto open / close" settings. (→Pages 30, 32) Even if "Auto flushing" is turned ON, "Auto flush lid closed" does not activate in the following cases.</p> <p>For about 60 seconds after the bowl unit flushes. ▶ After about 60 seconds have passed, use the remote control to flush the bowl unit. (→Page 20)</p> <p>When the time spent sitting on the toilet seat is less than about 6 seconds. ▶ Use the remote control to flush the bowl unit. (→Page 20)</p> <p>When the toilet is used in standing position. ▶ About 30 seconds after you leave the bathroom, the toilet seat and lid close and then the bowl unit flushes.</p>
The toilet lid closes too early or too late	<p>You can change "Auto flush delay" to modify the length of time before closing the toilet lid. (SET 1 / SET 2 / SET 3) (→Page 32)</p>

Energy Saver

Trouble	Please check
The Energy saver LED does not light up	<p>Has the power to the product been turned "OFF" or was there a power outage? The Energy saver LED on the main display may go off when the power is turned ON even if the energy saver feature is ON. It will turn on within about 24 hours since the setting is retained.</p>
The timer energy saver feature is not working	<p>Have the batteries in the remote control been replaced? "Timer energy saver" may be canceled when the batteries are replaced. ▶ Set the timer energy saver again at the time you want to start it. (→Page 29)</p>
The auto energy saver+ feature is not working	<p>Because this function takes several days learning the usage conditions before starting energy saver, the amount of energy saving may be low, depending on the frequency of use. ▶ Check the energy saver setting. (→Page 28)</p>

Deodorizer

Trouble	Please check
The deodorizer seems to be not working	<p>Is "Deodorizer" set to "OFF"? ▶ Set to "ON". (→Page 37)</p> <p>Even after sitting down, you do not hear operation sounds. ▶ Sit so your skin is in direct contact with the seat sensor. (→Page 9)</p> <p>If you hear an operation sound from the deodorizer, but odors are not removed. ▶ Clean the deodorizing filter. (→Page 50)</p>
A strange odor is emitted	<p>Are you using an air freshener or deodorizer that you purchased separately? Doing so may reduce the effectiveness of the product's deodorizer or cause strange odors. ▶ Remove the air freshener or deodorizer.</p>
The auto power deodorizer feature is not working	<p>Is "Auto power deodorizer" set to "OFF"? ▶ Set to "ON". (→Page 37)</p> <p>The auto power deodorizer starts about 10 seconds after you stand up from the toilet seat.</p>

Auto bowl CLEAN, Auto underseat CLEAN

Trouble	Please check
The mist does not work	<p>Is "Auto bowl CLEAN" set to "OFF"? ▶ Set to "ON". (→Page 36)</p> <p>The following functions do not work when the toilet seat is open. Is "Seat/lid" of "Auto open / close" set to "Seat+lid"? ▶ You can change it to "Lid". (→Page 34)</p> <p>If you use the PREMIST or EWATER+ mist immediately after the previous user leaves the bathroom, it may not be activated.</p>
Mist is not sprayed for "Auto underseat CLEAN"	<p>If "Auto bowl CLEAN" is turned OFF, mist is not sprayed for "Auto underseat CLEAN", either. ▶ Turn "Auto bowl CLEAN" ON. (→Page 36)</p>
Mist is not sprayed to the entire back of the toilet seat	<p>"Auto underseat CLEAN" and "Manual spray" spray mist underneath the front of the toilet seat that urine tends to splash on.</p>
The mist sprays out spontaneously	<p>Because the body sensor can detect movement through the wall or door in front of the toilet, the "Auto bowl CLEAN" function may cause the toilet to PREMIST even when you are outside of the bathroom. ▶ You can also set "Auto bowl CLEAN" to "OFF". (→Page 36)</p> <p>If the washing functions (e.g., Rear washing and Front washing) are not used for about 8 hours, "Auto bowl CLEAN" starts and mist is sprayed inside the bowl unit.</p>

Troubleshooting

Lights

Trouble	Please check
The soft light, bowl light and CLEAN indicator do not light up	Is the "Soft light", "Bowl light", or "CLEAN indicator" turned OFF? ▶ Set to "ON". (→Pages 39, 40)
The soft light lights permanently	Is "Night light" ("Night mode") turned ON? ▶ If it is turned ON, the Soft light lights permanently. You can also turn it OFF [STANDBY]. (→Page 38)

Others

Trouble	Please check
Water is leaking from the plumbing connections	If any nuts in a connection are loose, firmly tighten them with a tool such as a monkey wrench. ▶ If the water leak does not stop, close the shutoff valve and consult with TOTO customer service. (→see contact information on the back cover)
The display on the remote control goes out	The display goes out when no button on the remote control is pressed for about 60 seconds or more.
Water splashes up when using the toilet	The water in the bowl unit that is used to mask the smell of excrement is the cause of the splashing. ▶ Adding a layer of toilet paper on the surface of the water can slightly dampen splashing. You can lower the bowl unit water level. (→Page 42)
When flushing, you hear a squishy sound underneath the floor	There are cases when the sound is made inside the discharge pipe because of the device to ensure water in the bowl unit after the unit flushes.
When flushing, you hear a gurgling sound	When the toilet is flushed together with waste material, the sound is a result of air, waste material and water being pulled through the system.
There are black stain on or around the bowl unit	Ammonia in urine may cause black stains. ▶ If urine has splashed on the bowl unit or floor, wipe it immediately.

The top unit makes a sound

When entering the bathroom

If "Auto bowl CLEAN" is "ON", you may hear that PREMIST is spraying mist in the bowl unit to make it more difficult for dirt to adhere.

▶ You can turn it "OFF". (→Page 36)

When using the washing functions (Rear washing, Rear soft washing, or Front washing)

You can hear the sound of the pump operating while washing water is being supplied.

When moving away from the bowl unit after use

When "Auto power deodorizer" is "ON", operation sounds are made while the deodorizing power increases for 60 seconds after you stand up from the toilet seat.

▶ You can turn it "OFF". (→Page 37)

If "Auto wand CLEAN" is "ON" and you use the washing functions (e.g., Rear washing and Front washing), you may hear that the wand is extended and cleaned with "EWATER+".

▶ You can turn it "OFF". (→Page 35)

If "Auto bowl CLEAN" is "ON" and you sit on the toilet seat and use the toilet, you may hear that mist of "EWATER+" is sprayed inside the bowl unit.

▶ You can turn it "OFF". (→Page 36)

You may hear that the wand is extended and the remaining water in the product is drained after "Auto wand CLEAN" and other functions are performed.

When not using the product (e.g., at night)

You may hear the following sounds if "Auto wand CLEAN" or "Auto bowl CLEAN" is "ON" and if you do not use the washing functions (e.g., Rear washing and Front washing) for about 8 hours.

"Auto wand CLEAN" : Sound of cleaning the wand with "EWATER+".

: Sound of extending the wand and draining remaining water from the product after operation of functions.

"Auto bowl CLEAN" : Sound and operating noise of spraying EWATER+ mist on the bowl unit.

▶ You can turn it "OFF". (→Pages 35, 36)

Because the body sensor can detect movement through the wall or door in front of the toilet, the "Auto open / close" and "Auto bowl CLEAN" functions may cause the toilet to PREMIST, or the lid to open, even when you are outside of the bathroom.

▶ You can also set "Auto open / close" or "Auto bowl CLEAN" to "OFF".

(→Pages 32, 36)

▶ You can change the detection range of the body sensor. (→Page 45)

Operating noise may occur for extending the wand to prevent damage due to freezing by discharging the water remaining within the product.

Troubleshooting

Others (continue)

Trouble	Please check
There is black or pink slime on the bowl unit surface	It is a result of growth of airborne fungal spores or bacteria that feed on filth on the bowl unit. ▶ Clean with (non-abrasive) neutral toilet detergent.
There are water droplets on the bowl unit surface	Condensation occurs when the humidity is high, and there is a significant difference between water and room temperatures. ▶ Wipe off droplets with dry cloth. (Condensation can build up on condensation-proof bowls when the difference between room and water temperatures exceeds 59°F (15°C) and the ambient humidity reaches 80%.)
It takes a long time for the tank to fill	Is the shutoff valve fully open? (→Page 15) Is the water supply filter or drain plug with water supply filter clogged? ▶ Clean the filter. (→Pages 54, 55)
After the bowl unit is flushed, a bang is heard	Water hammer has occurred in the pipes while the water is supplied or stopped. ▶ Tighten the shutoff valve to reduce the water rate to an extent that does not affect a practical use of the toilet.
The top unit cannot be operated through the remote control	Follow the instructions "Please check first (A-C)". (→Page 63) The following conditions may affect the reception performance of the remote control, resulting in not being able to operate the top unit. <ul style="list-style-type: none"> • When the room size, the layout of fixtures etc., interferes • When the color of the ceiling or walls is too dark, or their shape or material interferes • When there is a rack or cabinet installed on the wall behind the top unit • When an inverter lighting system is used ▶ Change the position of the remote control and try again.

Specifications

Item	NEOREST LS
Rated power supply	AC 120 V, 60 Hz
Rated power consumption	1283 W
Maximum power consumption	1441 W
Type of water heater	Instantaneous type
Power cord length	3.9 ft (1.2 m)
Water protection level	IPX4
Bowl unit	
Flush volume	Full 1.0 gal (3.8 L), Light 0.8 gal (3.0 L)
Water supply system	Direct supply, Pressurized supply
Flush type	TORNADO FLUSH
Bowl style	Elongated
Anti freezing	
Dynamic mode	Flush volume (dynamic) ¹ : 7.7 gal/h (29 L/h)
Top unit	
Washing	
Spray volume ²	Rear washing: Approx. 0.08 - 0.11 gal/min (Approx. 0.32 - 0.43 L/min) Rear soft washing: Approx. 0.08 - 0.11 gal/min (Approx. 0.32 - 0.43 L/min) Front washing: Approx. 0.08 - 0.11 gal/min (Approx. 0.29 - 0.43 L/min) Wide front washing: Approx. 0.09 - 0.11 gal/min (Approx. 0.35 - 0.43 L/min)
Water temperature	Adjustable temperature range: OFF, about 86 - 104 °F (about 30 - 40 °C)
Heater capacity	1116 W
Safety device	Temperature fuse
Backflow prevention device	Vacuum breaker, Check valve
Heated seat	
Surface temperature	Adjustable temperature range: OFF, about 82 - 97 °F (about 28 - 36 °C) (Auto energy saver+: OFF)
Heater capacity	470 W
Safety device	Temperature fuse
Deodorizer	
Method	O ₂ deodorization
Airflow volume	Normal mode: Approx. 3.17 ft ³ /min (Approx. 0.09 m ³ /min) Power mode: Approx. 5.65 ft ³ /min (Approx. 0.16 m ³ /min)
Power consumption	Normal mode: Approx. 1.6 W, Power mode: Approx. 4.0 W
Warm air dryer	
Warm air temperature ³	Adjustable temperature range: about 95 - 140 °F (about 35 - 60 °C)
Airflow volume	Approx. 8.83 ft ³ /min (Approx. 0.25 m ³ /min)
Heater capacity	258 W
Safety device	Temperature fuse
Water supply pressure	Minimum required water pressure: 7.25 PSI (0.05 MPa) <Dynamic, 2.6 gal/min (10 L/min)>, Maximum water pressure: 108.75 PSI (0.75 MPa) <Static>
Water supply temperature	32 - 95 °F (0 - 35 °C)
Working ambient temperature	32 - 104 °F (0 - 40 °C)
Dimensions	W 1.35 x D 2.38 x H 1.74 ft (W 411 x D 725 x H 529 mm)
Weight	About 112 lb (about 51 kg) <Top unit about 15 lb (about 7 kg), Bowl unit about 97 lb (about 44 kg)>

When disposing of this product, please follow your local or state guidelines for proper disposal.

*1 The flush volume changes depending on water pressure.

*2 At 29 PSI (0.20 MPa) (dynamic) water pressure

*3 Temperature around the warm air outlet measured by TOTO.

MEMO

MEMO

Limited Warranty

Three Years Limited Warranty

1. TOTO warrants its product to be free from defects in materials and workmanship during normal use when properly installed and serviced, for a period of three (3) years from date of purchase. This limited warranty is extended only to the ORIGINAL PURCHASER of the Product and is not transferable to any third party, including but not limited to any subsequent purchaser or owner of the Product.
This warranty applies only to TOTO Product is purchased and installed in USA and Canada.
2. TOTO's obligations under this warranty are limited to repair, replacement or other appropriate adjustment, at TOTO's option, of the Product or parts found to be defective in normal use, provided that such Product was properly installed, used and serviced in accordance with instructions.
TOTO reserves the right to make such inspections as may be necessary in order to determine the cause of the defect. TOTO will not charge for labor or parts in connection with warranty repairs or replacements. TOTO is not responsible for the cost of removal, return and/or reinstallation of the Product.
3. This warranty does not apply to the following items:
 - a) Damage or loss sustained in a natural calamity such as fire, earthquake, flood, thunder, electrical storm, etc.
 - b) Damage or loss resulting from any accident, unreasonable use, misuse, abuse, negligence, improper care, or maintenance of the Product.
 - c) Damage or loss resulting from sediments or foreign matter contained in a water system.
 - d) Damage or loss resulting from the quality of water in the region where the product is used.
 - e) Damage or loss resulting from improper installation or from installation of the Product in a harsh and/or hazardous environment, or improper removal, repair or modification of the Product. This includes locations where the water pressure is above local codes or standards. (NOTE : Product model codes allow a maximum of 80 PSI. Check local codes or standards for requirements).
 - f) Damage or loss resulting from electrical surges or lightning strikes or other acts which are not the fault of TOTO or which the Product is not specified to tolerate, including failure to use the factory equipped cord and plug or use of a loose or faulty electrical outlet or use of a current or socket other than a 120 V, 60 Hz electrical current from a GFI (ground, fused) socket.
 - g) Damage or loss resulting from normal and customary wear and tear, such as gloss reduction, scratching or fading over time due to use, cleaning practices or water or atmospheric conditions, including but not limited to, the use of bleach, alkali, acid cleaners, dry (powder) cleaners or any other abrasive cleaners or the use of metal or nylon scrubbers.

4. If the Danger Label which has been placed over the seams on the back of the Product's top unit is broken or otherwise not intact, this limited warranty is void.
5. In order for this limited warranty to be valid, proof of purchase is required. TOTO encourages warranty registration upon purchase to create a record of Product ownership at <http://www.totousa.com>. Product registration is completely voluntary and failure to register will not diminish your limited warranty rights.
6. If the Product is used commercially or is installed outside of USA or Canada. TOTO warrants the Product to be free from defects in materials and workmanship during normal use for one (1) year from the date of installation of the Product, and all other terms of this warranty shall be applicable except the duration of the warranty.
7. This warranty gives you specific legal rights. You may have other rights which vary from state to state, province to province or country to country.
8. To obtain warranty repair service under this warranty, you must take the Product or deliver it prepaid to a TOTO service facility together with proof of purchase (original sales receipt) and a letter stating the problem, or contact a TOTO distributor or products service contractor, or write directly to TOTO U.S.A., INC., 1155 Southern Road, Morrow, GA 30260 (888) 295 - 8134 or (678) 466-1300, if outside the U.S.A. If, because of the size of the Product or nature of the defect, the Product cannot be returned to TOTO, receipt by TOTO of written notice of the defect together with proof of purchase (original sales receipt) shall constitute delivery. In such case, TOTO may choose to repair the Product at the purchaser's location or pay to transport the Product to a service facility.

WARNING! TOTO shall not be responsible or liable for any failure of, or damage to, this Product caused by either chloramines in the treatment of public water supply or cleaners containing chlorine (calcium hypochlorite).

NOTE: The use of a high concentrate chlorine or chlorine related product's can seriously damage the fittings. This damage can cause leakage and serious property damage.

THIS WRITTEN WARRANTY IS THE ONLY WARRANTY MADE BY TOTO. REPAIR, REPLACEMENT OR OTHER APPROPRIATE ADJUSTMENT AS PROVIDED UNDER THIS WARRANTY SHALL BE THE EXCLUSIVE REMEDY AVAILABLE TO THE ORIGINAL PURCHASER. TOTO SHALL NOT BE RESPONSIBLE FOR LOSS OF THE PRODUCT OR FOR OTHER INCIDENTAL, SPECIAL OR CONSEQUENTIAL DAMAGES OR EXPENSES INCURRED BY THE ORIGINAL PURCHASER, OR FOR LABOR OR OTHER COSTS DUE TO INSTALLATION OR REMOVAL, OR COSTS OF REPAIRS BY OTHERS, OR FOR ANY OTHER EXPENSE NOT SPECIFICALLY STATED ABOVE. IN NO EVENT WILL TOTO'S RESPONSIBILITY EXCEED THE PURCHASE PRICE OF THE PRODUCT. EXCEPT TO THE EXTENT PROHIBITED BY APPLICABLE LAW, ANY IMPLIED WARRANTIES, INCLUDING THAT OF MERCHANTABILITY OR FITNESS FOR USE OR FOR A PARTICULAR PURPOSE, ARE EXPRESSLY DISCLAIMED. SOME STATES DO NOT ALLOW LIMITATIONS ON HOW LONG AN IMPLIED WARRANTY LASTS, OR THE EXCLUSION OR LIMITATION OF INCIDENTAL OR CONSEQUENTIAL DAMAGES, SO THE ABOVE LIMITATION AND EXCLUSION MAY NOT APPLY TO YOU.