

SPECIFICATIONS

DESCRIPTION

- 1 function

FLOW

- 1.8 GPM/6.7 LPM at 60 PSI (WaterSense and CEC compliant)

STANDARDS

- A112.18.1/ CSA B125.1
- CEC Compliant

WARRANTY

- Most products or parts carry "Limited Warranties" against manufacturing defects. For US customers please visit houseofrohl.com/support and for Canadian customers please visit houseofrohl.ca/support for complete product and finish warranty.



10" Rain Showerhead

MODEL: I00412

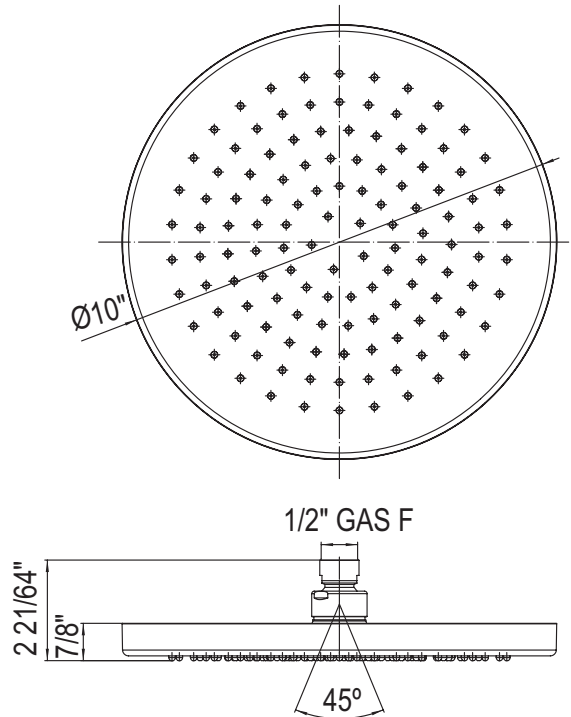

For warranty or additional information, contact:

U.S.A.
houseofrohl.com/support
 1-800-777-9762

QUEBEC / MARITIMES / WESTERN CANADA
 QUÉBEC / MARITIMES / OUEST CANADIEN
 QUEBEC / MARITIMOS / CANADA OCCIDENTAL
houseofrohl.ca/support
 1-866-473-8442

ONTARIO
houseofrohl.ca/support
 1-800-287-5354

SPÉCIFICATIONS

DESCRIPTION

- 1 fonction

DÉBITS DISPONIBLES

- 1,8 GPM/6,7 LPM à 60 PSI (conforme WaterSense et CEC)

CERTIFICATION

- A112.18.1/ CSA B125.1
- Conforme CEC

GARANTIE

- La plupart des produits ou pièces comportent des « garanties limitées » contre les défauts de fabrication. Pour les clients américains, veuillez visiter houseofrohl.com/support et pour les clients canadiens, veuillez visiter houseofrohl.ca/support pour la garantie complète du produit et du fini.



Tête de douche pluie 10"

MODÈLES: I00412

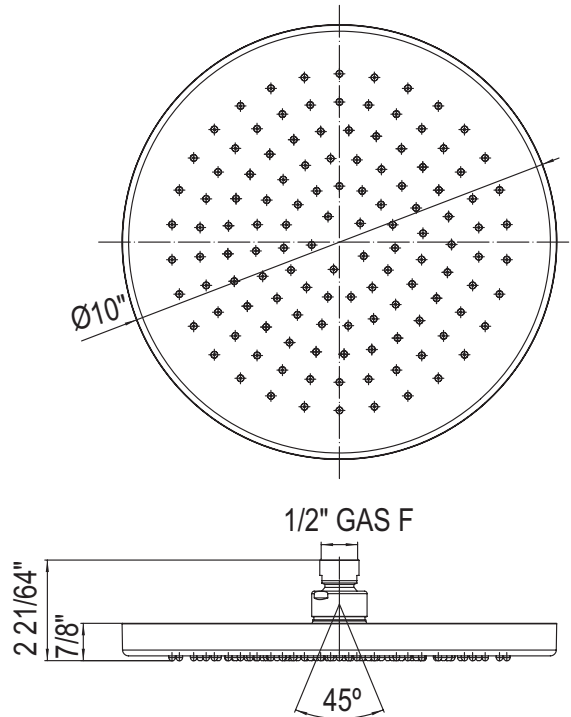

For warranty or additional information, contact:

U.S.A.
houseofrohl.com/support
 1-800-777-9762

QUEBEC / MARITIMES / WESTERN CANADA
 QUÉBEC / MARITIMES / OUEST CANADIEN
 QUEBEC / MARITIMOS / CANADA OCCIDENTAL
houseofrohl.ca/support
 1-866-473-8442

ONTARIO
houseofrohl.ca/support
 1-800-287-5354

ESPECIFICACIONES

DESCRIPCIÓN

- 1 función

FLUIR

- 1,8 GPM/6,7 LPM à 60 PSI (Cumple con CEC)

NORMAS

- A112.18.1/ CSA B125.1
- Cumple con CEC

GARANTÍA

- La mayoría de los productos o piezas cuentan con "Garantías limitadas" contra defectos de fabricación. Para los clientes de EE. UU., visite houseofrohl.com/support y para los clientes canadienses, visite houseofrohl.ca/support para conocer la garantía completa del producto y el acabado.



Cabezal de ducha tipo lluvia de 10"

MODELOS: I00412

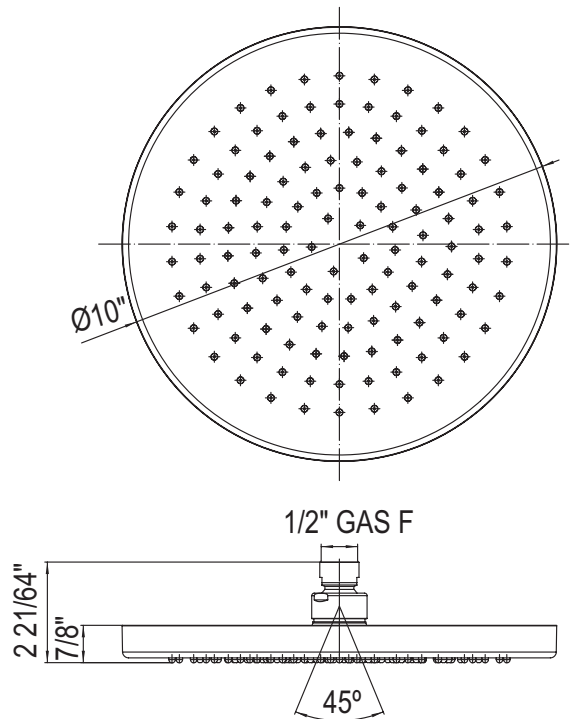

For warranty or additional information, contact:

U.S.A.
houseofrohl.com/support
 1-800-777-9762

QUEBEC / MARITIMES / WESTERN CANADA
 QUÉBEC / MARITIMES / OUEST CANADIEN
 QUEBEC / MARITIMOS / CANADA OCCIDENTAL
houseofrohl.ca/support
 1-866-473-8442

ONTARIO
houseofrohl.ca/support
 1-800-287-5354