

ROHL SHOWER DRAIN - ABS & PVC INSTALLATION INSTRUCTIONS

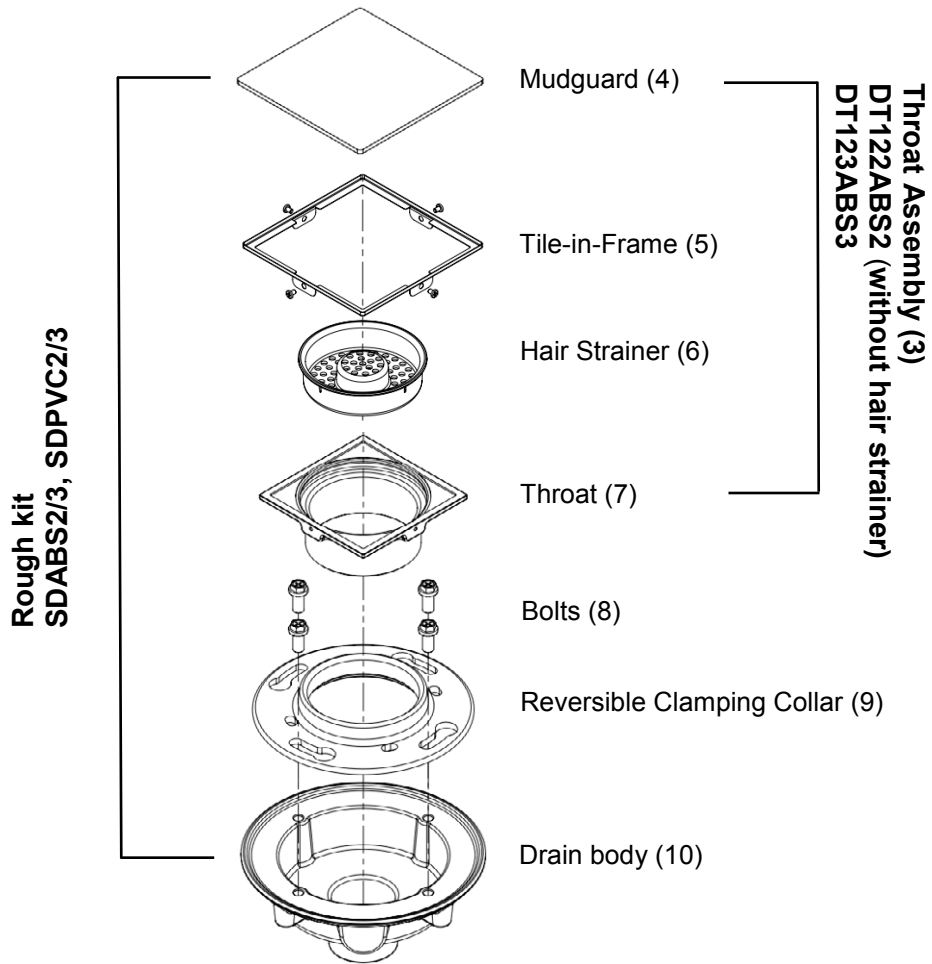

Note: This product to be installed by licensed contractor(s), only.

Wooden Floor Installations

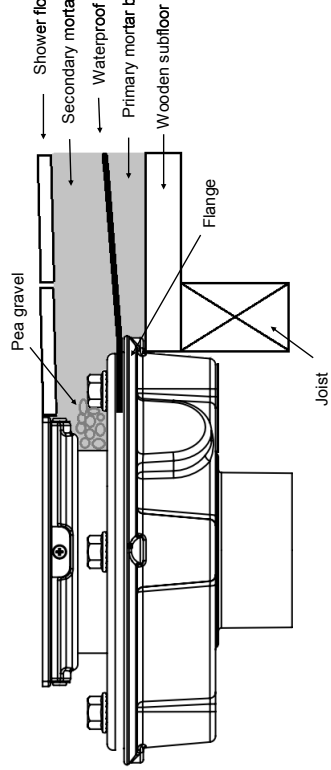

Install Drain Body (10) - Wood Sub-Floor Application:

1. Remove drain throat assembly (3), clamping collar (9) and all four bolts (8). Cut a **maximum 7 5/16"** diameter hole in wooden sub-floor where drain will be positioned. Hole should be large enough for body to fit through and flange to rest on top. (As shown above.)
3. Apply silicone sealant to drain body as appropriate.
4. Connect drain body outlet to pre-installed waste line with P-Trap.
 - a. ABS body with ABS solvent cement.
 - b. PVC body with PVC primer and solvent cement.
5. Let cement dry.
6. Test for leaks as per plumbing and local building codes.
7. Brace and strap drain and piping as needed for proper support.

Install Drain Body (10) - Cement Sub-Floor Application:

1. Remove drain throat assembly (3), clamping collar (9) and all four bolts (8).
2. Connect drain body outlet to pre-installed waste line with P-trap.
 - a. ABS body with ABS solvent cement.
 - b. PVC body with PVC primer and solvent cement.
3. Let cement dry.
4. Test for leaks as per plumbing and local building codes.
5. Back fill around the drain body with dirt and concrete for proper drain support.

Apply Primary Mortar Bed:

1. Before applying mortar, cover drain body opening with tape or other material to keep out debris.
2. Apply mortar bed at 1/4" per foot slope from the wall framing to edge of drain body flange using industry standard procedures.
 Note: - The mortar must not cover the flange of drain body and must be kept clean.
 - Sloped mortar bed is to be flush with flange of drain body.

Concrete Floor Installations

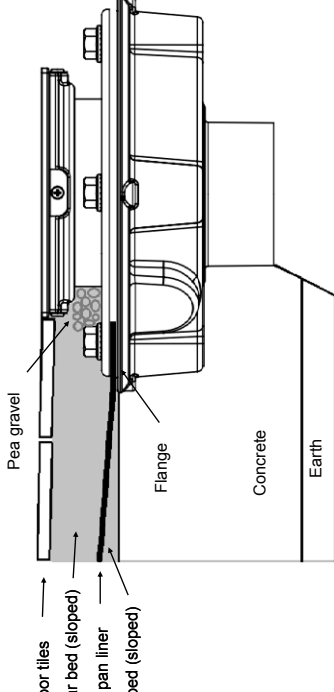

Install Membrane/Waterproof Pan Liner:

1. When the primary mortar bed has cured, install waterproof membrane/shower pan liner. Ultimately this is to be fitted between drain flange and reversible clamping collar.
2. Waterproof membrane/shower pan liner shall be installed as per manufacturer's instructions and plumbing and local building codes.

Install Reversible Clamping Collar (9):

1. Carefully cut opening for drain inlet and bolt holes through pan liner.
 - a. Drain in-let: The drain inlet should already be aligned with the center of the pan liner. Make a cut approximately 5 3/8" in diameter, leaving at least 1/4" rim of pan liner from the edge of the drain body to the opening. Be sure weep holes are not obstructed by pan liner material.
 - b. Drain bolt openings: Cut the pan liner just enough to expose bolt holes and start bolts. Cuts to be as minimal as possible.
2. Screw clamping collar bolts (8) into bolt holes several threads deep into drain body.
3. Depending on flooring thickness, place reversible clamping collar either in the up or down position over the bolts at larger opening on collar and twist collar to lock into place. Ensure the flange height remains flush to pan liner.
 - a. The clamping collar is designed to form water tight seal to pan liner without adhesive.
4. Tighten all four bolts to complete the seal.
5. Test the pan liner to be sure it is water tight by plugging the drain body outlet and filling the shower floor with water. (Test plug not supplied.) Conduct test according to local codes.
6. Once tested remove plug and drain water.

Installing Throat Assembly (3):

1. To obtain proper drain cover height, rotate throat assembly with tile-in-frame and mud guard to height of finished flooring; raise or lower as appropriate. Proper height should be determined by accounting for the reinforced mortar bed, thin set, and tile thickness.
 Before the application of the mortar bed, place pea gravel over the weep holes to prevent blockage of the openings.
- 2.

Apply Secondary Mortar Bed and Tiling:

1. Apply secondary mortar bed as per manufacture's recommendations.
2. Finish floor with thin set and tiling installation.

Install Decorative Cover (2):

See instructions with decorative cover.

Care and Maintenance:

For all chrome plated surfaces clean this product with warm soapy water and then dry with a dry soft cloth.

Nickel plated, satin and Inca brass finishes should be cleaned with a soft cloth and warm water. Then dry with a dry soft cloth.

Do not use cream cleaners or cleaning agents containing a corrosive acid or scouring agent including: Softscrub, Comet, Ajax and Bonami, as these may damage the surface of the faucet.

Do not use any spray cleaners with ammonia or alcohol like Windex, 409 or Fantastik.

Any use of unsuitable cleaning agents causing damage to the surface will not be covered by the warranty.

Limited Warranty:

The ROHL decorative drain is warranted to be free of defects in material and workmanship for one (1) year from date of purchase by the original owner. The warranty is not transferable and is extended to the original purchaser of the product. Products must be installed in accordance with the installation instructions provided with the products. Due to the nature of drain usage, the finish is excluded from the warranty. For all terms and conditions, see complete warranty in ROHL's price book.