

# LS-AZ035

## BATHROOM VESSEL SINK

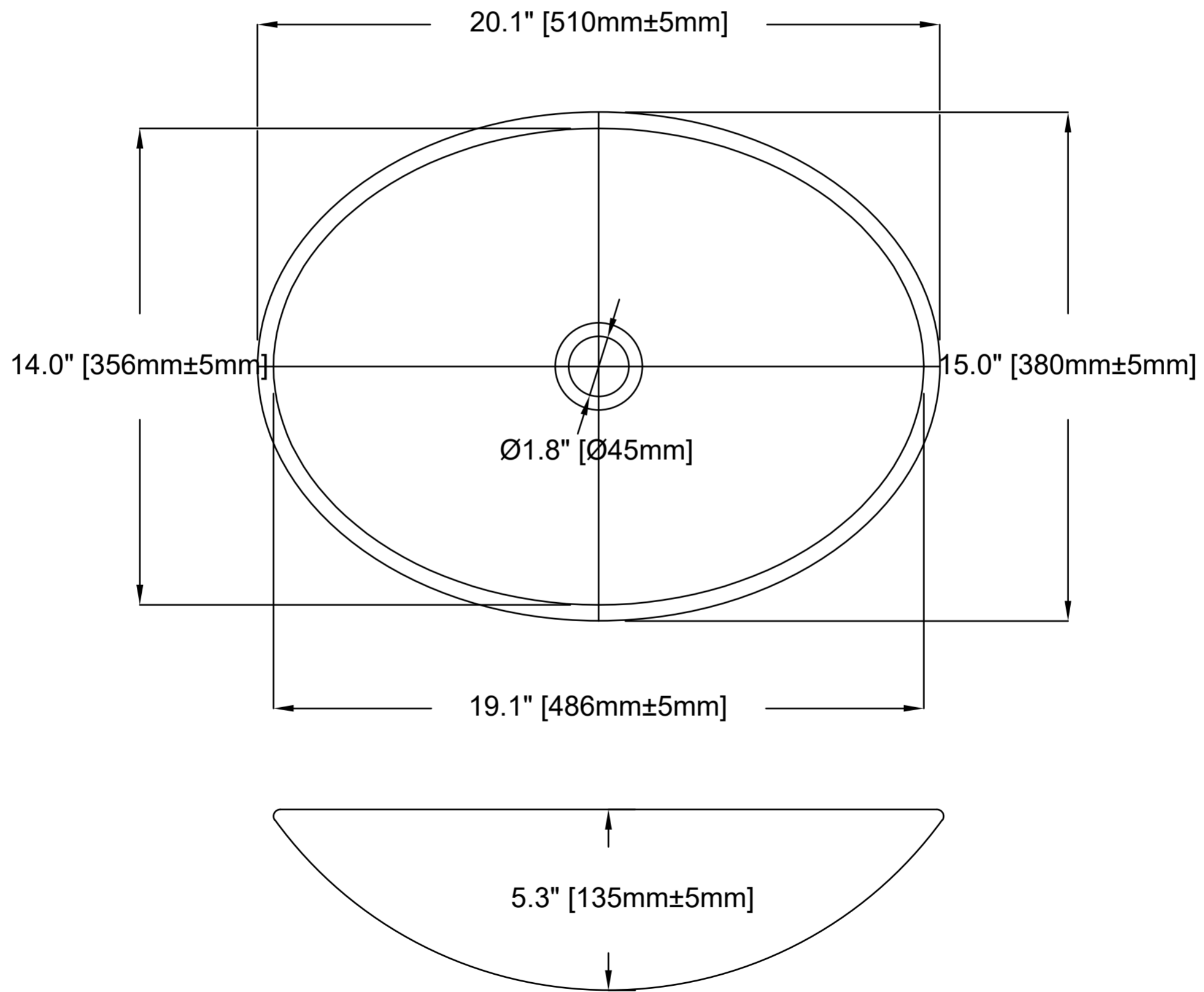

HAVE QUESTIONS? CALL 305-614-4070 OR VISIT [ANZZI.COM](https://www.anzzi.com)